

## LX Lever Puller

### 1/4 and 1/2 Ton Capacities

Harrington's LX mini puller is lightweight, compact and built to perform. It fits conveniently in a toolbox and will easily handle pulling and moving jobs in many applications including transportation, construction and plumbing. Available in two capacities to fit all applications. The 1/2 Ton capacity is unique to the industry.

#### Many Benefits from More Features:

- Durable die-cast aluminum body with steel frame is compact and lightweight.
- Very low headroom design for use in tight spaces.
- Free-chain mechanism allows for quick adjustments.
- Extremely low pulling force is required for operation.
- Weston-style brake is totally enclosed to protect against dirt, dust and rain.
- Single step reduction gear assures load holding performance.
- Load chain guide mechanism permits smooth and quiet guiding of chain.
- Rubber handle grip for ease of use.
- Effortless to transport, install and store.

#### Options: (See page 32)

- Heavy duty carrying case

#### Capabilities to Count On:

- Grade 100, nickel-plated load chain is corrosion and wear resistant.
- Strong hook latches include notched tip.
- 5-foot lift is standard. Longer lifts are available in both capacities.
- Sold individually or in convenient multi-packs—1/4 Ton in 6-packs and 1/2 Ton in 4-packs.
- Test certificate verifies that every hoist has been factory load tested to 125% of rated capacity in accordance with ASME B30.21 requirements.



1/4 Ton

1/2 Ton

**LX LEVER PULLER — SPECIFICATIONS & DIMENSIONS**

Cap. (Tons)	Product Code	Headroom C (in)	Std. Lift (ft)	Pull to Lift Load (lbs)	a (in)	b (in)	D (in)	e (in)	g (in)	Load Chain Diameter (mm) x Chain Fall Lines	Net Weight (lbs)	Shipping Weight Approx. (lbs)	Weight for Additional One Foot of Lift (lbs)
1/4	LX003	8.1	5	40	3.5	2.9	5.9	2.4	0.8	3.2 x 1	3.5	4.0	0.15
1/2	LX005	9.7		62	3.9	3.7	7.1	2.7	0.9	4.3 x 1	5.7	6.2	0.25

Weights are approximate.

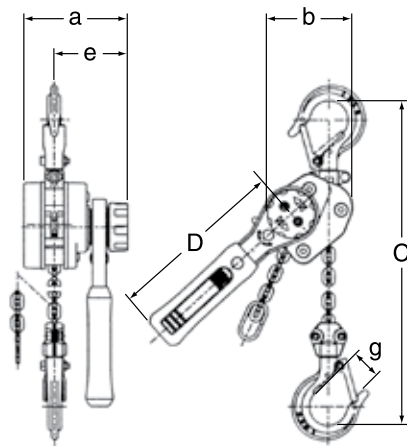

1/4 Ton LX

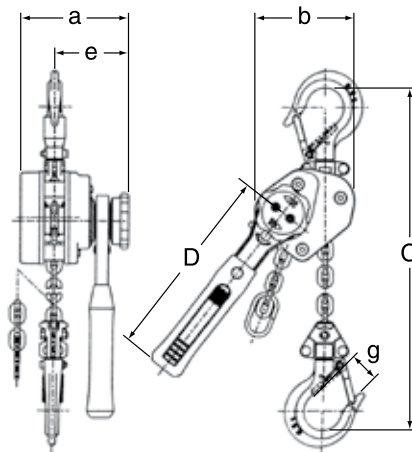

1/2 Ton LX