



HANDLING  
SYSTEMS  
INTERNATIONAL

# OWNER'S MANUAL

## MODEL 350/350F

### LIGHT DUTY FREESTANDING JIB CRANE

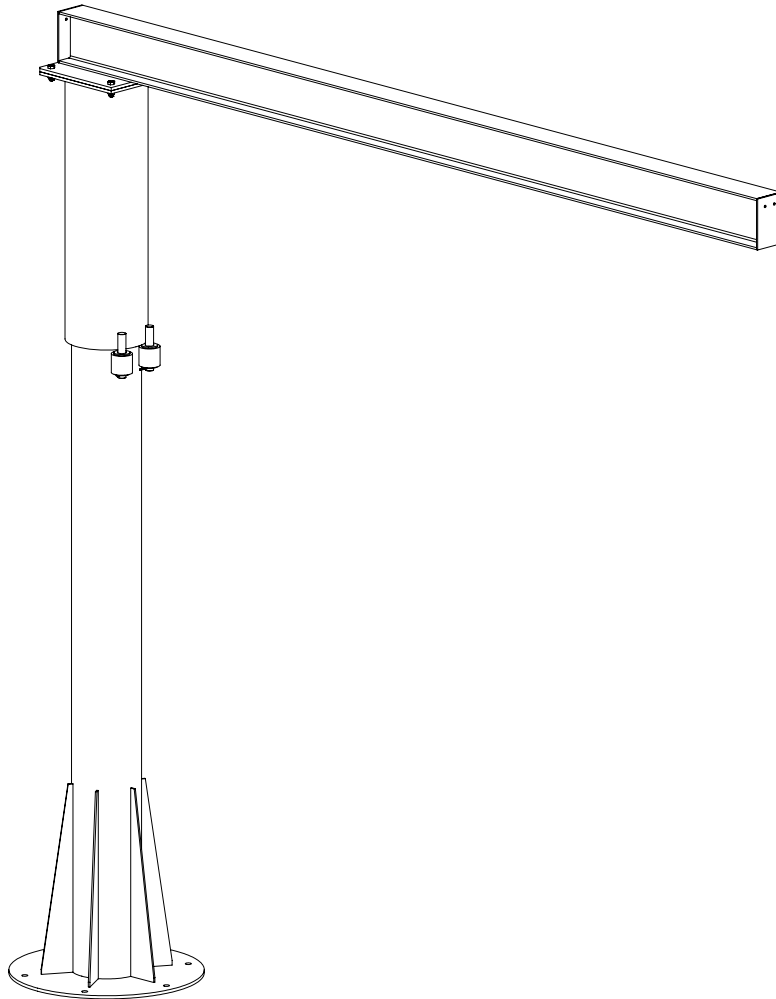

**SERIAL #:**

#### WARNING

This equipment should not be installed, operated or maintained by any person who has not read and understood all the contents of this manual. Failure to read and comply with the contents of this manual can result in serious bodily injury or death, and/or property damage.

PHONE (888) 352-1213 • FAX (708) 352-6593 • McCook, IL

# Table of Contents

<u>Section</u>	<u>Page Number</u>
Important Information and Warnings.....	3
Technical Information and Specifications.....	4
Crane Terms.....	5
Pre-Installation.....	6
Installation.....	7
Head and Boom Installation.....	10
Rotation Stops (If Applicable).....	11
Tight Wire Kit (If Applicable).....	12
Operation Introduction.....	13
Shall's and Shall Not's for Operation.....	14
Maintenance Inspection.....	15
Lubrication.....	16
Troubleshooting.....	17
Warranty.....	18
Parts Information.....	19
Parts Breakdown.....	20

## WARNING

ONLY COMPETENT ERECTION PERSONNEL FAMILIAR WITH STANDARD FABRICATION PRACTICES SHOULD BE EMPLOYED TO ASSEMBLE HANDLING SYSTEMS CRANES BECAUSE OF NECESSITY IN INTERPRETING THESE INSTRUCTIONS. HANDLING SYSTEMS IS NOT RESPONSIBLE FOR QUALITY OF WORKMANSHIP PERFORMED DURING CRANE INSTALLATION.

## WARNING

ALL HANDLING SYSTEMS EQUIPMENT IS NOT DESIGNED FOR OR MADE FOR TRANSPORTING HUMANS. FAILURE TO COMPLY WITH ANY ONE OF THE LIMITATIONS STATED IN THIS CRANE MANUAL CAN RESULT IN PROPERTY DAMAGE, INJURY, OR DEATH. PLEASE TAKE ALL NECESSARY PRECAUTIONS DURING INSTALLATION.

## WARNING

CONSULT WITH A QUALIFIED STRUCTURAL ENGINEER TO DETERMINE IF YOUR SUPPORT STRUCTURE IS ADEQUATE TO SUPPORT THE LOADS GENERATED BY ANCHOR BOLT FORCE, OVERTURNING MOMENT, OR AXIAL LOAD OF YOUR CRANE.

## WARNING

CRANE CANNOT BE UTILIZED AS A GROUND: A SEPARATE GROUND WIRE IS REQUIRED.

## WARNING

DO NOT MODIFY CRANE IN ANY WAY. ANY ALTERATIONS DONE IN THE FIELD WITHOUT CONSENT FROM HANDLING SYSTEMS WILL VOID ALL WARRANTY.

## WARNING

OVERLOADING AND IMPROPER USE CAN RESULT IN INJURY

## WARNING

- MANUAL MUST BE FULLY READ AND UNDERSTOOD BY QUALIFIED ERECTION PERSONNEL PRIOR TO INSTALLATION AND USE OF PRODUCT.
- CRANE IS NOT DESIGNED FOR AND SHOULD NOT BE USED FOR LIFTING OR TRANSPORTING HUMANS
- CRANE CAN NOT BE UTILIZED AS A GROUND.
- DO NOT FIELD MODIFY CRANE IN ANY WAY
- CONSULT WITH QUALIFIED STRUCTURAL ENGINEER TO DETERMINE IF JIB CRANE SUPPORT STRUCTURE IS ADEQUATE BASED ON THE LOADS GENERATED BY THE JIB CRANE



# Technical Information and Specifications

## Product Code for Light Duty Pillar Base Mounted Jib Crane

**350 - 1000 - 08 - 10**

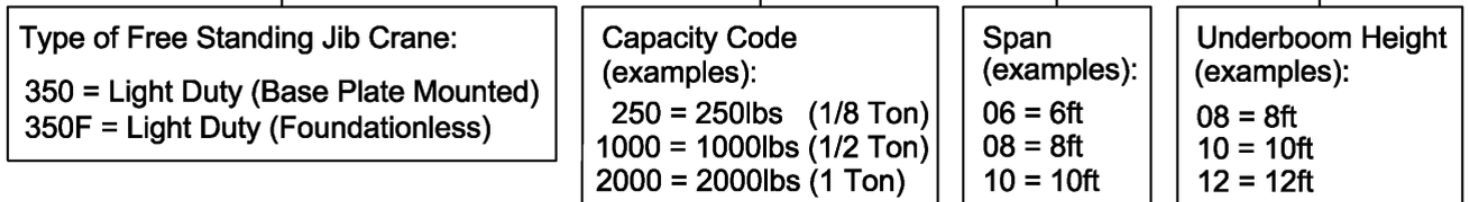

## Operating Conditions and Environment

Temperature range: -30°F to +150°F (-34°C to 66°C)

Relative Humidity: 85% or less



## Crane Terms

In order to better understand jib cranes, here are the commonly used terms that are used to specify and design jibs.

- **Anchor Bolts:** Large steel bolts used to mount a base mounted pillar jib crane to the H.S.I. recommended foundation.
- **Boom:** The horizontal beam on which the hoist trolley travels.
- **Fitting Centers:** The distance, centerline to centerline, between two support brackets (fittings) of a wall mounted jib crane.
- **Capacity:** The maximum live weight that the crane is designed to support.
- **End Stops:** Bolted to each end of the boom to prevent the trolley from falling off of the beam.
- **Foundation:** For free standing pillar base mounted jibs. Foundations are used to support the jib and prevent it from tipping over.
- **Gussets:** Reinforcing plates used to stiffen mast at the base plate.
- **Head:** Houses the roller, and lowers the crushing forces that are imposed on the mast.
- **Height Under the Boom (H.U.B.):** The distance from the finished floor to the underside of the crane boom. To find the under-boom, take the height of the load, plus the distance the load is lifted, plus the headroom requirements of the hoist/trolley and any attachments. Extra room aside from mandatory room needed could be helpful.
- **Mast:** The vertical member of the jib, which supports the crane. Pillar jibs have round pipes as masts.
- **Overall Height:** The highest point of the jib crane (including any hardware). A minimum clearance (usually 3") is required from any overhead obstruction.
- **Hoist:** The actual lifting mechanism (powered by electric, air, or manual movement) that hangs from the trolley that rides on the boom of a jib crane.
- **Trolley:** The mechanism that travels back and forth on the crane boom (powered by electric, air, or manual movement) which the hoist hangs from.
- **Overtopping Moment:** The overtopping moment is the force applied to the mounting structure of a self-supporting pillar jib. This load is created by suspending a load from the boom, and is greatest at full load, at the very end of the boom.
- **Rotation Stops:** Limits the rotation of a pillar base mounted jib crane boom (which are standard at 360°). Stops are field welded to the mast.
- **Span:** The span for a pillar base mounted jib crane is the distance from the center of the mast to the end of the boom. The span for a column mounted crane is measured from the face of the mounting surface to the end of the boom. The span for a mast type jib crane is measured from the center of the vertical mast to the end of the boom.
- **Thrust and Pull:** Thrust and Pull are forces applied to a wall/column mounted jib cranes support structure. Thrust is the pushing force exerted on the structure, and pull is the tensile, or pulling force. Thrust and Pull are equal to each other (but opposite in direction), and are given for maximum at full load at the end of the boom.
- **Clear Span:** The measurement between the end stops on a crane boom.
- **Hook Travel:** The distance that the hook on the hoist travels.

## Pre-Installation

1. Check jib crane for physical damage due to shipping.
2. Ensure all capacity stickers and warning labels are clearly visible and properly affixed.
3. Check packing list to ensure no parts have been lost prior to initiating assembly of crane
4. See Foundation Drawing and Jib Crane Drawing for bolt locations and dimensions.
5. Read entire manual before installing the crane.
6. Identify crane model (Model 350 has a poured foundation and Model 350F uses the existing floor). Find the applicable assembly instructions on page 7 and 8 based on the model type.



# CAUTION

**IT IS RECOMMENDED THAT FOUNDATIONLESS JIB CRANES BE MOUNTED ON REINFORCED CONCRETE WITH A MINIMUM DEPTH OF 6" AVOIDING ANY GAPS, CRACKS, OR EXPANSION JOINTS. ANCHOR BOLTS MUST HAVE A 4 3/4" MINIMUM EMBEDMENT.**

**IT IS NOT HANDLING SYSTEMS INTERNATIONAL INC.'S RESPONSIBILITY TO VERIFY THE SUITABILITY OF A FLOOR OR STRUCTURE TO WHICH OUR PRODUCT IS MOUNTED. PRIOR TO MOUNTING, IT IS REQUIRED THAT THE CUSTOMER/END USER SEEK ADVICE FROM A QUALIFIED ENGINEER.**

VISIT [WWW.HSICRANE.COM](http://WWW.HSICRANE.COM) FOR OWNER'S MANUAL OR CONTACT 888-352-1213

## Installation

**WARNING** If multiple cranes were ordered, locate stamped serial number on each crane part for proper part matching during installation. Although crane parts may appear to be identical, each crane is assembled and built separately. All parts that do not have the same stamped serial number may not line up properly for installation.

### **Model 350: Light Duty – Base Mounted:**

1. Reference the Foundation Drawing and Jib Crane Drawing included in the jib crane information packet.
2. **WARNING** Consult a qualified structural engineer to determine that your support structure is adequate to support the loads generated by anchor bolt force, overturning moment, or axial load of your crane. Suggested foundation requirements and curing times are recommendations only. Because conditions may vary, consult a qualified professional to verify foundation requirements.
3. **NOTICE** Foundation requirements are based on a soil pressure of 2500 lbs. per square foot. Concrete recommended for jib crane foundation is 3000 lbs. per square inch or compressive force.
4. **NOTICE** Recommended curing time for foundation/concrete before mast installation is 10 days. Recommended curing time for foundation/concrete before loading crane to full capacity is 28 days.
5. Pour foundation with ANCHOR BOLTS located according to base plate bolt pattern (see **Foundation Drawing**).
6. After foundation is properly cured, spread grout over foundation approximately 1" thick & the same diameter as BASE PLATE (or square dimensions for applicable models). See **Foundation Drawing**. Grout must be a non-shrink, high compressive machinery type grout.
7. Lower MAST ASSEMBLY over ANCHOR BOLTS and set on foundation grout surface. Tighten ANCHOR BOLTS until MAST ASSEMBLY is plumb in all directions (see **Figure 1**). Grout is soft and will allow BASE PLATE to settle for plumbing procedure.  
**WARNING Plumbing of mast assembly is very important and will affect performance of jib crane**
8. After grout has properly cured, fully tighten ANCHOR BOLTS to manufacturer's specification. Verify that the MAST ASSEMBLY is still plumb.
9. Locate THRUST BEARING, lubricate with high grade grease and set on BEARING PIN at the top of the MAST ASSEMBLY (see Figure 7).
10. Proceed to **Page 9** to install HEAD and BOOM assembly.

## Model 350F: Light Duty – “Foundationless”:

1. Reference the Jib Crane Drawing included in the jib crane information packet.
2. **WARNING** Consult a qualified structural engineer to determine that your support structure is adequate to support the loads generated by anchor bolt force, overturning moment, or axial load of your crane. Customer is responsible for determining adequacy of the existing concrete floor prior to mounting
3. **WARNING** Existing concrete must be a minimum of 6” thick reinforced, 3000 lbs. per square inch, with a soil content of 3,000 lbs. per square foot. Concrete in and around mounting site must be consistent and free of any cracks, joints, seams, walls, or wearing.
4. **WARNING** Installer is responsible for providing proper anchors for install based on diameter and jib crane reactions.
5. Install chemical ANCHOR BOLTS with a *minimum* of 4-3/4” embedment (See **Figure 2**). ANCHOR BOLT must have a minimum of two threads above nut after installation. **NOTE: Refer to Hilti-HY 200-A instruction manual booklet for proper anchor installation.**
6. Spread mechanical grout over floor approximately 1” thick & the same diameter as BASE PLATE. See Foundation Drawing. Grout must be a non-shrink, high compressive machinery type grout.
7. Lower MAST ASSEMBLY over ANCHOR BOLTS and set on foundation grout surface. Tighten ANCHOR BOLTS until MAST ASSEMBLY is plumb in all directions (see **Figure 1**). Grout is soft and will allow BASE PLATE to settle for plumbing procedure.  
**WARNING Plumbing of mast assembly is very important and will affect performance of jib crane**
8. After grout has properly cured, fully tighten ANCHOR BOLTS to manufacturer’s specification. Verify that the MAST ASSEMBLY is still plumb.
9. Proceed to **Page 9** “Head and Boom Installation”

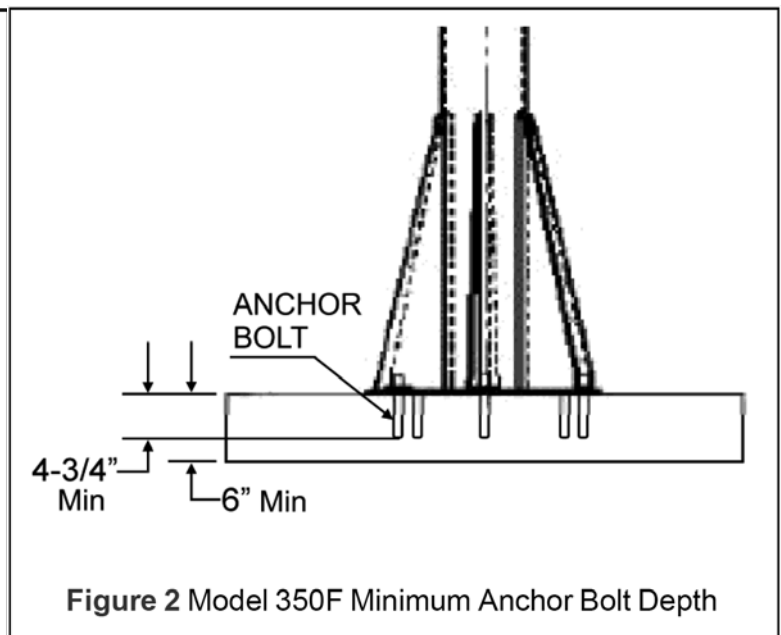
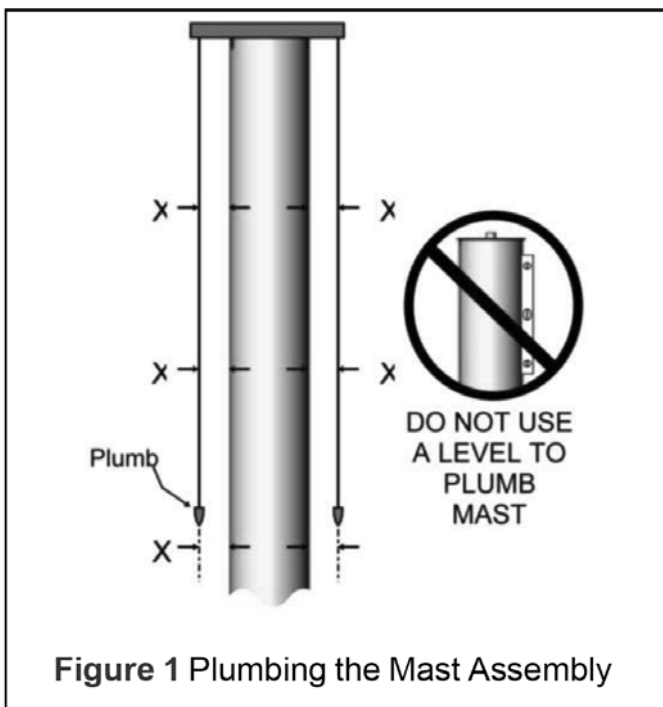

NOTE: IT IS NOT HANDLING SYSTEMS INTERNATIONAL INC.'S RESPONSIBILITY TO VERIFY THE SUITABILITY OF A FLOOR OR STRUCTURE TO WHICH OUR PRODUCT IS MOUNTED. PRIOR TO MOUNTING, IT IS REQUIRED THAT THE CUSTOMER/END USER SEEK ADVICE FROM A QUALIFIED ENGINEER.

PRIOR TO INSTALLATION, CHECK EPOXY EXPIRATION DATE! DO NOT USE IF EPOXY HAS EXPIRED

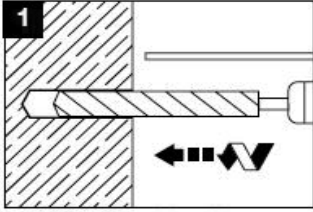

1. Drill anchor hole with a carbide bit for a 4-3/4" anchor bolt embedment. Concrete must be minimum 6" thick, 3000 psi, and free and clear of cracks seams or voids within a 6' square mounting area.

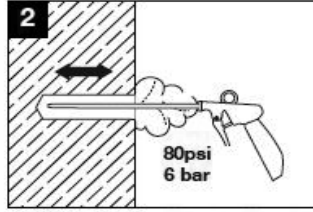

2. Insert air nozzle to bottom of hole and blow out all dust and debris from the hole using compressed air.

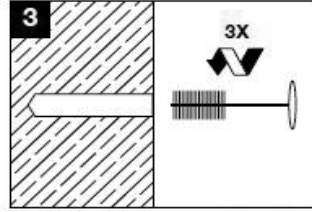

3. Clean hole with wire brush. Proper hole cleaning is essential.

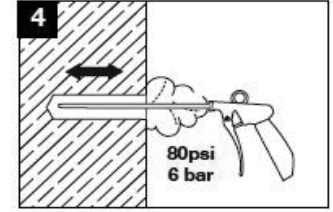

4. Insert air nozzle to bottom of hole and blow out all dust and debris from the hole using compressed air.

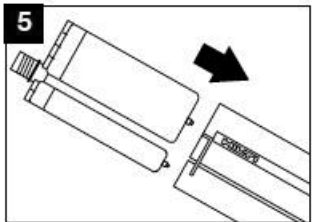

5. Put foil pack of epoxy into holder. Remove cap covering threaded projection. Do not pierce seal.

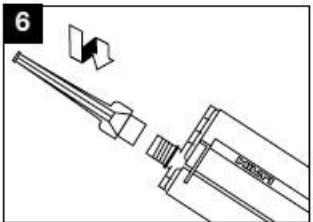

6. Screw on static mixer to epoxy tube.

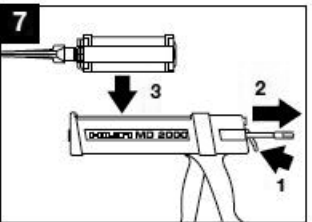

7. Put holder/foil pack into dispenser.

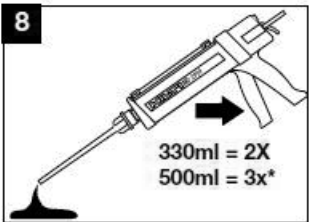

8. Squeeze trigger until you here epoxy being dispensed (seal will break on its own). Discard first 2 trigger pulls of adhesive to ensure proper mix when inserting into hole. \*\*Below 41° F (5°C) discard four trigger pulls.

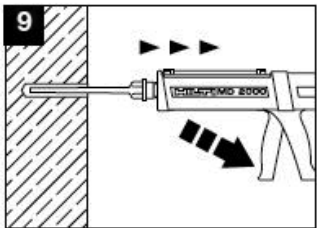

9. Inject adhesive into hole without forming air pockets starting at BOTTOM of hole until 80% of hole is filled with epoxy. Use tube extension if necessary.

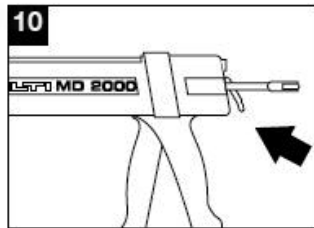

10. After injecting adhesive depressurize the dispenser by pressing the release button. NOTE: Epoxy dries QUICKLY, immediately move to steps 11 & 12. See "work" time in table below.

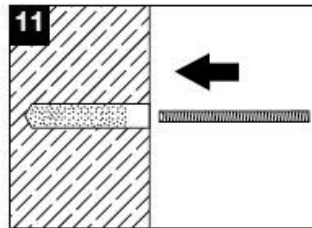

11. Gently insert threaded rod/Hit-Z anchor into hole. Twist during installation. Adjust anchor to level before moving to next hole. Excess ep-oxly should come out of the anchor hole. Excess epoxy will be easily removed with a chisel after epoxy is cured. Do not attempt to clean excess epoxy before it is cured.

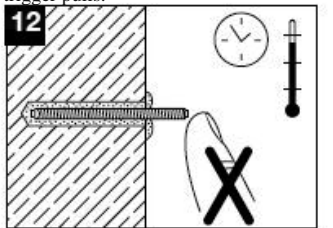

12. Do not disturb anchor between specified gel and cure time. Refer to cure time in table below before proceeding to step 13.

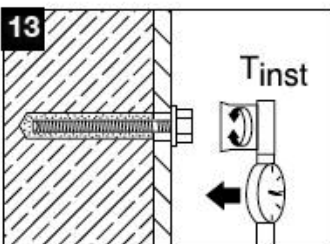

13. After epoxy is properly cured install flat washer and nut and apply specified torque. Do not exceed maximum torque specified.

[°C]	[°F]	WORK	CURE
-10...-5	14...23	1.5 h	7 h
-4...0	24...32	50 min	4 h
1...5	33...41	25 min	2 h
6...10	42...50	15 min	1.25 h
11...20	51...68	7 min	45 min
21...30	69...86	4 min	30 min
31...40	87...104	3 min	30 min

## Head and Boom Assembly

1. Reference **Figure 3** for general assembly layout.
2. After grout has hardened, lubricate TOP PIN on MAST ASSEMBLY and TOP THRUST BEARING with high grade grease and set HEAD ASSEMBLY over TOP PIN. Make sure BEARING fits over any imperfections caused by shipping.
3. Bolt the BOOM ASSEMBLY to the HEAD ASSEMBLY.
4. Under no load condition, adjust the BOOM ASSEMBLY so that the far end of the boom is span(in.)/300 above the horizontal. Ensure rollers are making full contact with MAST ASSEMBLY. If additional adjustment to tip of boom is needed a steel shim (max 5/8" thick) should be inserted UNDER the boom flange at the boom to head assembly connection. After shim is placed adjust tip of boom elevation with method described above. (min. shim width/length: length of boom flange x 2 inches in width x 5/8" thick maximum). See figure 3 for shim location.
5. If applicable, install MECHANICAL ROTATION STOPS – See **Page 10**.
6. For units with Tight Wire Kits, please refer to page 11 for Tight Wire Kit Installation instructions.
7. Rotate BOOM slowly and check around 360° for binds or slow down spots. Remove interference if any.
8. Tighten all bolts to specified torque (see Table 1) and unit should be ready for operation.

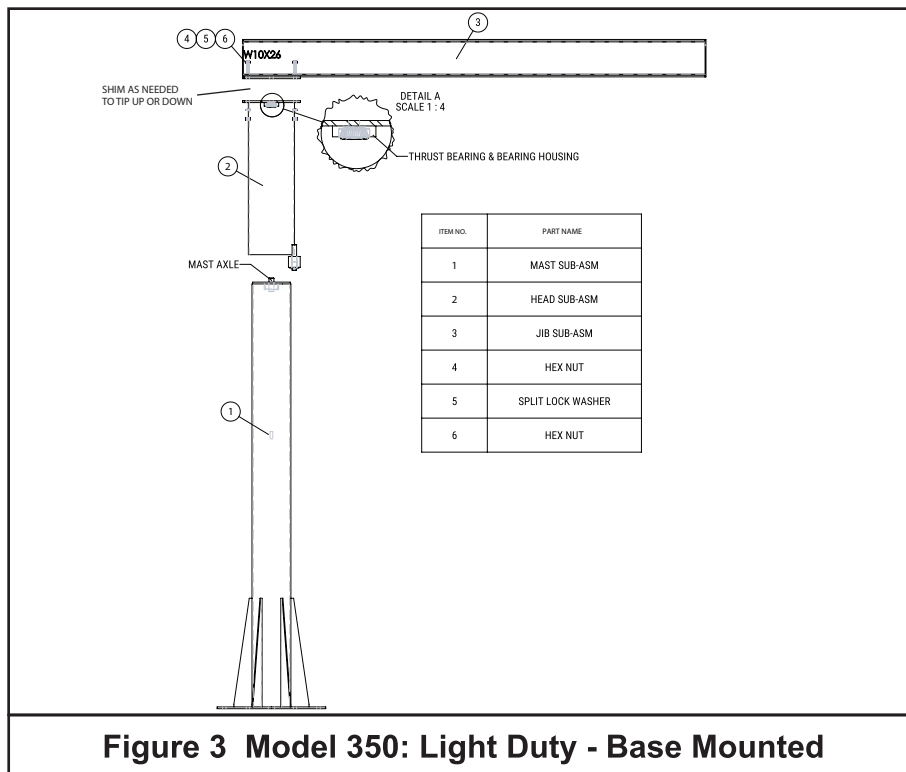

BOLT DIA.	TORQUE
1/4" - 20	6 ft.-lbs.
3/8" - 16	20 ft.-lbs.
1/2" - 13	50 ft.-lbs.
5/8" - 11	95 ft.-lbs.
3/4" - 10	175 ft.-lbs.
7/8" - 9	300 ft.-lbs.

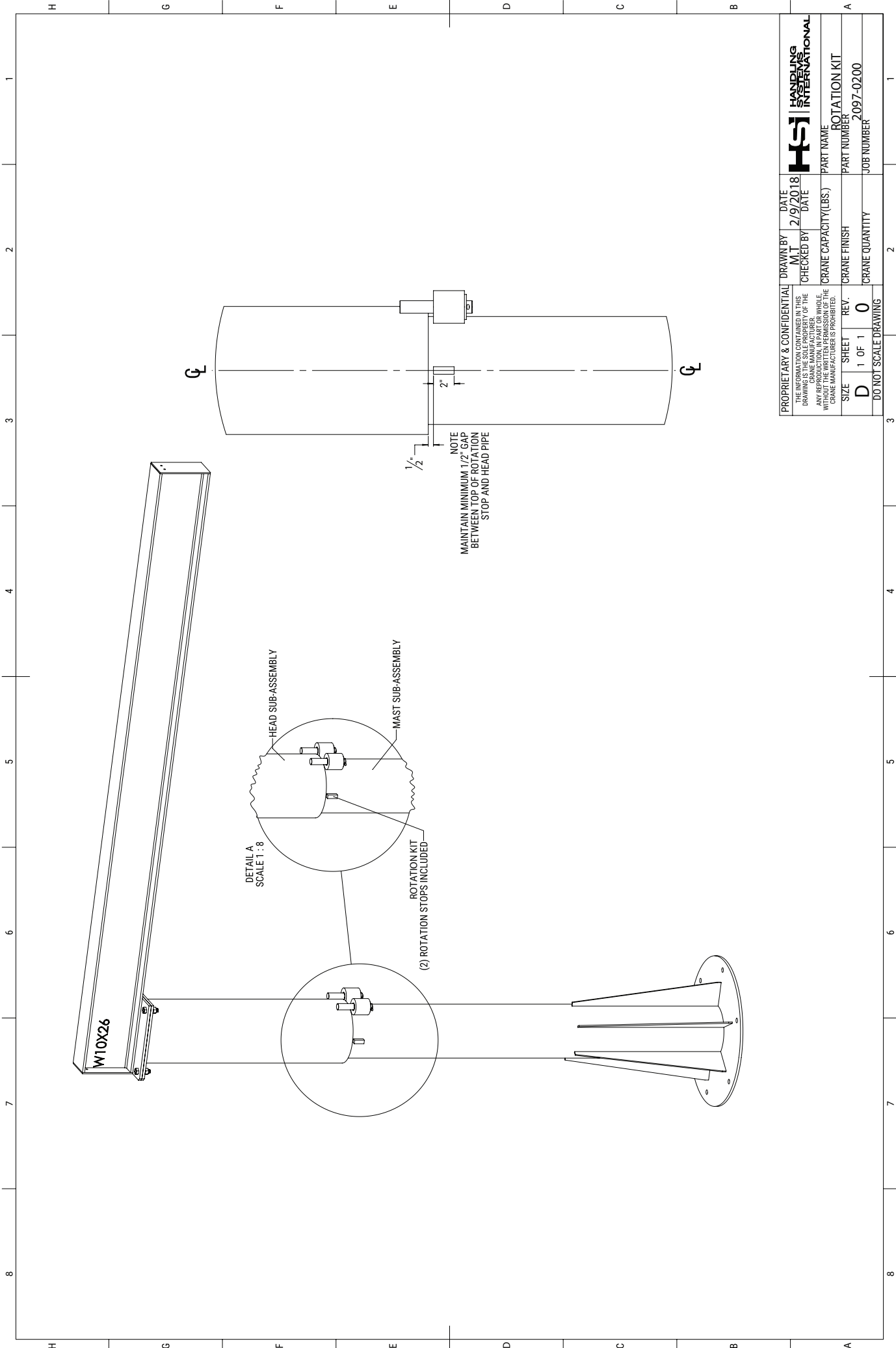

PROPRIETARY & CONFIDENTIAL		DRAWN BY	DATE
THE INFORMATION CONTAINED IN THIS DRAWING IS THE PROPERTY OF THE CRANE MANUFACTURER. ANY REPRODUCTION IN PART OR WHOLE WITHOUT THE WRITTEN PERMISSION OF THE CRANE MANUFACTURER IS PROHIBITED.		M.T.	2/9/2018
DO NOT SCALE DRAWING		CHECKED BY	DATE
SIZE	SHEET	CRANE CAPACITY(LBS)	PART NAME
D	1 OF 1	0	ROTATION KIT
	REV	CRANE FINISH	PART NUMBER
	0		2097-0200
		CRANE QUANTITY	JOB NUMBER
		2	



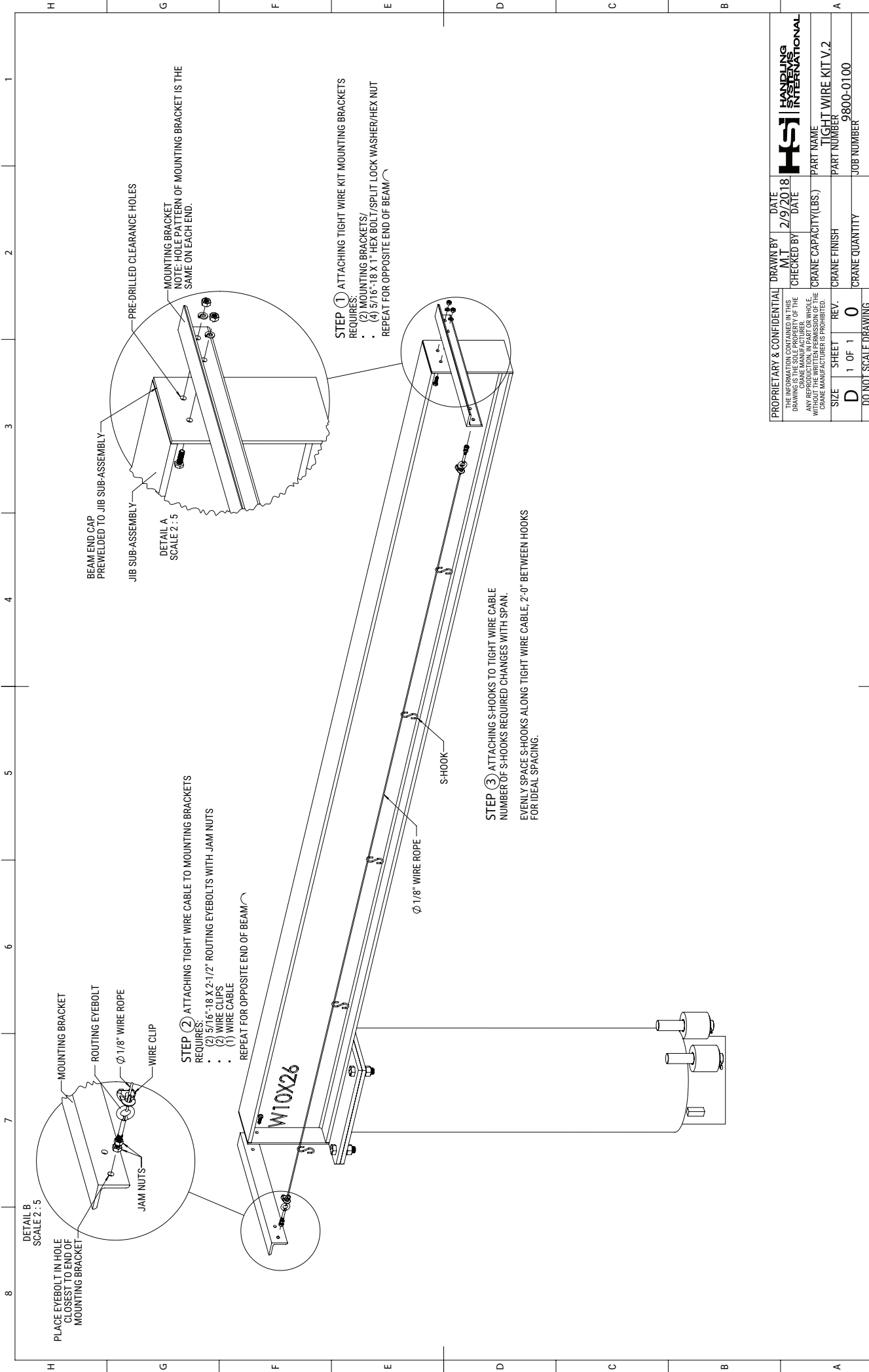

DETAIL B  
SCALE 2 : 5

PLACE EYEBOLT IN HOLE  
CLOSEST TO END OF  
MOUNTING BRACKET

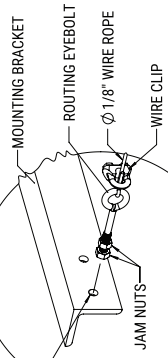

**STEP 2 ATTACHING TIGHT WIRE CABLE TO MOUNTING BRACKETS**

- REQUIRES:
- (2) 5/16" - 18 X 2-1/2" ROUTING EYEBOLTS WITH JAM NUTS
  - (2) WIRE CLIPS
  - (1) WIRE CABLE

REPEAT FOR OPPOSITE END OF BEAM

DETAIL A  
SCALE 2 : 5

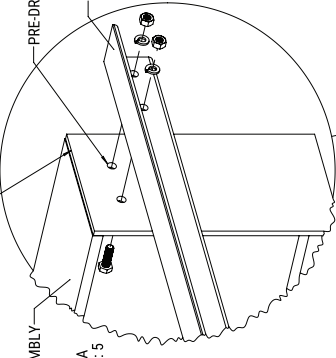

BEAM END CAP  
PREWELDED TO JIB SUB-ASSEMBLY

PRE-DRILLED CLEARANCE HOLES

MOUNTING BRACKET  
NOTE: HOLE PATTERN OF MOUNTING BRACKET IS THE  
SAME ON EACH END.

**STEP 1 ATTACHING TIGHT WIRE KIT MOUNTING BRACKETS**

- REQUIRES:
- (2) MOUNTING BRACKETS/
  - (4) 5/16" - 18 X 1" HEX BOLT/SPLIT LOCK WASHER/HEX NUT

REPEAT FOR OPPOSITE END OF BEAM

**STEP 3 ATTACHING S-HOOKS TO TIGHT WIRE CABLE**

NUMBER OF S-HOOKS REQUIRED CHANGES WITH SPAN.  
EVENLY SPACE S-HOOKS ALONG TIGHT WIRE CABLE, 2'-0" BETWEEN HOOKS  
FOR IDEAL SPACING.

PROPRIETARY & CONFIDENTIAL		DRAWN BY	DATE
THE INFORMATION CONTAINED IN THIS DRAWING IS THE PROPERTY OF THE CRANE MANUFACTURER. ANY REPRODUCTION, IN PART OR WHOLE, WITHOUT THE WRITTEN PERMISSION OF THE CRANE MANUFACTURER IS PROHIBITED.		M.T.	2/9/2018
CHECKED BY		DATE	
SIZE	SHEET	REV.	CRANE CAPACITY(LBS.)
D	1 OF 1	0	TIGHT WIRE KIT V.2
DO NOT SCALE DRAWING		CRANE FINISH	PART NUMBER
		CRANE QUANTITY	9800-0100
			JOB NUMBER



PART NAME  
TIGHT WIRE KIT V.2  
PART NUMBER  
9800-0100  
JOB NUMBER



## Operation Introduction

The suggestions below are not intended to take precedence over existing plant safety rules and regulations or OSHA regulations. It is the responsibility of the owner to make personnel aware of all federal, state and local rules and codes, and to make certain operators are properly trained.

### **DANGER**

**DO NOT WALK UNDER A SUSPENDED LOAD**

**KEEP HANDS CLEAR OF ROTATING PARTS**

### **WARNING**

CRANE OPERATORS SHALL BE REQUIRED TO READ THE OPERATION SECTION OF THIS MANUAL, THE WARNINGS CONTAINED IN THIS MANUAL, INSTRUCTION AND WARNING LABELS ON THE HOIST OR LIFTING SYSTEM, APPLICABLE ANSI AND OSHA SAFETY STANDARDS, AND THE CRANE OPERATOR'S MANUAL PUBLISHED BY THE CRANE MANUFACTURER'S ASSOCIATION OF AMERICA (CMAA). THE OPERATOR SHALL ALSO BE REQUIRED TO BE FAMILIAR WITH THE CRANE AND CRANE CONTROLS BEFORE BEING AUTHORIZED TO OPERATE THE CRANE OR LIFTING SYSTEM.

CRANE OPERATORS SHOULD BE TRAINED IN PROPER RIGGING PROCEDURES FOR THE ATTACHMENT OF LOADS TO THE HOIST HOOK.

CRANE OPERATORS SHOULD BE TRAINED TO BE AWARE OF POTENTIAL MALFUNCTIONS OF THE EQUIPMENT THAT REQUIRE ADJUSTMENT OR REPAIR, AND TO BE INSTRUCTED TO STOP OPERATION IF SUCH MALFUNCTIONS OCCUR, AND TO IMMEDIATELY ADVISE THEIR SUPERVISOR SO CORRECTIVE ACTION CAN BE TAKEN.

CRANE OPERATORS SHOULD HAVE NORMAL DEPTH PERCEPTION, FIELD OF VISION, REACTION TIME, MANUAL DEXTERITY, HEARING, AND COORDINATION.

CRANE OPERATORS SHOULD NOT HAVE A HISTORY OF OR BE PRONE TO SEIZURES, LOSS OF PHYSICAL CONTROL, PHYSICAL DEFECTS, OR EMOTIONAL INSTABILITY THAT COULD RESULT IN ACTIONS OF THE OPERATOR BEING A HAZARD TO THE OPERATOR OR TO OTHERS.

CRANE OPERATORS SHOULD NOT OPERATE A CRANE OR LIFTING SYSTEM WHEN UNDER THE INFLUENCE OF ALCOHOL, DRUGS, OR MEDICATION.

### **NOTICE**

**Read OSHA Specification 1910.179 "Overhead and Gantry Cranes," ANSI B30.11, "Monorails and Underhung Cranes," ASMEB30.16, and any other applicable standards.**

**Read the hoist manufacturer's Operating and Maintenance Instructions.**

**Read all labels attached to equipment.**

## Shall's and Shall Not's for Operation

### WARNING

Improper operation of a crane can create a potentially hazardous situation which, if not avoided, could result in death or serious injury, and substantial property damage. To avoid such a potentially hazardous situation **THE OPERATOR SHALL:**

- **NOT** operate a damaged, malfunctioning or unusually performing crane.
- **NOT** operate a crane until you have thoroughly read and understood Manufacturer's Operating and Maintenance Instructions or Manuals.
- Be familiar with operating controls, procedures, and warnings.
- **NOT** operate a crane that has been modified without the manufacturer's approval.
- **NOT** lift more than rated load for the crane/hoist/trolley.
- **NOT** use the crane to lift, support, or transport people.
- **NOT** lift loads over people.
- **NOT** operate a crane unless all persons are and remain clear of the supported load.
- **NOT** operate unless load is centered under hoist.
- **NOT** leave load supported by the crane/hoist unattended unless specific precautions have been taken.
- **NOT** allow the crane to be used as an electrical or welding ground.
- **NOT** remove or obscure the warnings on the crane.
- **NOT** operate a crane on which the safety placards or decals are missing or illegible.
- **NOT** operate a crane that has any changes in rolling effort or unusual noises.
- Warn personnel before lifting or moving a load.
- Warn personnel of an approaching load.
- Ensure that end-stops are in place.
- Ensure that all bolts are tight and have lockwashers.
- **NOT** put hands near rotating parts.

### WARNING

Improper operation of a crane can create a potentially hazardous situation which, if not avoided, could result in minor or moderate injury, or property damage. To avoid such a potentially hazardous situation **THE OPERATOR SHALL:**

- Maintain a firm footing or be otherwise secured when operating the crane.
- Make sure the load is free to move and will clear all obstructions.
- Avoid swinging the load or hook.
- Inspect the crane regularly, replace damaged or worn parts, and keep appropriate records of maintenance.
- Use the crane manufacturer's recommended parts when repairing the unit.
- Lubricate the roller bearings per crane manufacturer's recommendations.
- **NOT** allow your attention to be diverted from operating the crane.
- **NOT** allow the crane to be subjected to sharp contact with other cranes, structures, or objects through misuse.
- **NOT** adjust or repair the crane unless qualified to perform such adjustments or repairs.
- Ensure that festooning cannot be snagged or pinched.

### JIB BOOM OPERATION

- Verify the hook is high enough to clear any obstruction before using the boom of the jib crane.
- Ensure the jib boom is directly over the load before lifting the load.
- Start moving the jib boom slowly and bring it up to speed gradually.
- Reduce the speed of the boom as it approaches the place where it should stop.

### TROLLEY OPERATION

- Refer to the trolley's operating instructions.

### HOIST OPERATION

- Refer to the hoist's operating instructions.

## Maintenance Inspection

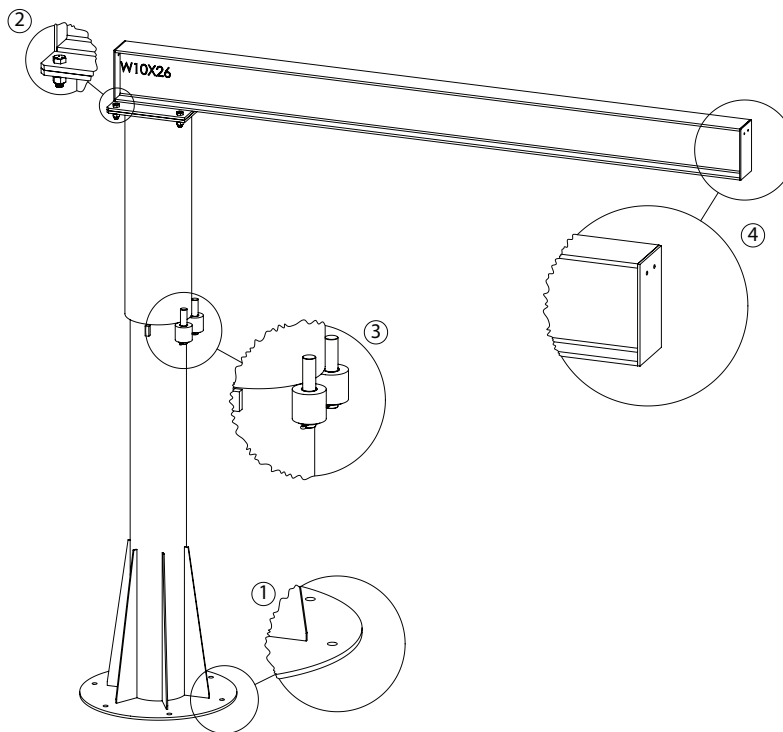

Figure No.	Item	Inspection	Frequency	
1	Anchor Bolts	Check that the lock-washers are fully compressed and the nuts are tightened to manufacturer's specifications.	350	Every 500 hours Or 3 months
	Chemical Anchor Bolts		350F	Once Per Month
2	Boom Hardware	Check that the lock-washers are fully compressed and the nuts are tightened the proper torque specs (see Figure 1 page).	Every 500 hours Or 3 months	
3	Rollers	Make sure both rollers are evenly touching the mast, adjust if needed. Grease if needed.	Every 1000 hours Or 6 months	
4	End Stop/Tight Wire Kit	Check that the lock-washers are fully compressed and the nuts are tightened the proper torque specs (see Figure Page).	Every 500 hours Or 3 months	
-	Additional Items	Conduct a general inspection of all additional items you may have purchased.	Every 1000 hours Or 6 months	
-	General	Conduct a visual inspection of the crane overall and speak with the crane operator about the cranes performance, if any flaws are noticed take crane out of service and report to manufacturer immediately.	Every 1000 hours Or 6 months	

## WARNING

Any changes in rolling effort or unusual noises must be immediately identified and corrected.

## Lubrication

1. The most economical way to maintain a jib crane and keep it in good operating condition is to lubricate all moving parts regularly.
2. Regular inspection of all parts should be made and all loose parts should be adjusted. Parts that become worn should be replaced immediately.
3. The lubrication interval varies with the use of the machine. A crane operating 24 hours a day, 7 days a week, should demand lubrication once a week. Whereas a standard duty crane, operating eight hours a day on a five day week should be lubricated once every two to three weeks. Cranes under a standby classification, being used once or twice a month, should be lubricated at least once every six months.
4. The actual interval from one lubrication to the next depends entirely upon the type and length of operation to which the crane is subjected. These factors are variable and sometimes cannot be definitely determined. In this case, the crane operator or maintenance engineer would determine when the crane should be lubricated.
5. The roller bearings on the jib crane require lubrication. They are serviced by pressure type fittings.
6. The recommended lubricants for these bearings are:
  - a. Texaco Marfax No. 0 for below 32 degrees F
  - b. Texaco Marfax No. 1 for above 32 degrees F
7. If Texaco products are not available, equivalent lubricants are satisfactory.

## Troubleshooting

<b>Troubleshooting Guide</b>		
<b>Symptom</b>	<b>Cause</b>	<b>Remedy</b>
Jib crane does not rotate smoothly	Mast pin is not inserted into the bearing housing in the head assembly	Properly insert mast pin into the bearing housing
Jib crane does not rotate a complete rotation	Crane boom has an obstruction	Remove any obstruction
	Mast pin is not inserted into the bearing housing in the head assembly	Properly insert mast pin into the bearing housing



# 11 Year Warranty

**HSI's 11 year warranty is the best in the industry.**

## **What Products Are Covered?**

- Manual Rotation Jib Cranes
- Manual Steel Gantry Cranes
- Defects in material and workmanship

## **The Fine Print:**

Handling Systems International, Inc. (known as H.S.I.) warrants manual push/pull Jib and Gantry Crane products it manufactures against defects in material or workmanship for a period of eleven years from date of receipt by purchaser or customer. This warranty does not cover failure or defect in paint or material finish. This warranty does not cover failure or defect caused by operation in excess of recommended rated capacities, misuses, negligence or accident, and alteration or repair of any kind not authorized by H.S.I. H.S.I. systems shall not be modified after manufacture without written authorization of H.S.I. Any field modifications made without written authorization of H.S.I. shall void all H.S.I.'s warranty obligation. H.S.I. agrees to furnish the same or substantially similar replacement part (new or repaired) free of charge, providing the buyer gives immediate written notice of alleged defects, and if requested by H.S.I., returns the defective parts to the factory, for H.S.I.'s inspection and examination. Purchaser or end user shall be solely responsible for all freight and transportation costs incurred in connection with any warranty work provided by H.S.I. hereunder. H.S.I. will not be liable for any loss, injury or damage to persons or property, nor for damages of any kind resulting from failure or defective operation of any materials or equipment furnished hereunder. H.S.I. shall not be liable under any circumstances for any incidental, special and/or consequential damages whatsoever, whether or not foreseeable, including but not limited to damages for lost profits and all such incidental, special and/or consequential damages are hereby also specifically disclaimed. This warranty applies only to H.S.I. equipment or materials which, after our inspection, are determined to be defective either in material supplied or workmanship performed by H.S.I. Where equipment is furnished by H.S.I. but not of its manufacture, H.S.I.'s liability is limited to such adjustment as the actual manufacturer makes to H.S.I. H.S.I. will not be liable for the cost of repairs, alterations, or replacements or any expense connected therewith made or incurred by the purchaser or his agents or employees, except upon written authority from H.S.I. This warranty is personal to purchaser only and applies only to equipment which purchaser has properly operated and maintained in accordance with H.S.I.'s written instructions. H.S.I. assumes no liability for any consequential damages suffered through the use of loss of use of its equipment. This constitutes H.S.I.'s sole warranty with respect to the equipment and material manufactured by itself. H.S.I. makes no other warranty of any kind whatsoever, expressed or implied, and all implied warranties of merchantability and fitness for a particular purpose which exceed the aforementioned obligation are hereby disclaimed by H.S.I.

## Parts Information

When ordering Parts, please provide the crane serial number which is stamped into each crane part (see **Figure 9**). The serial number is also located underneath the “HSI” logo.

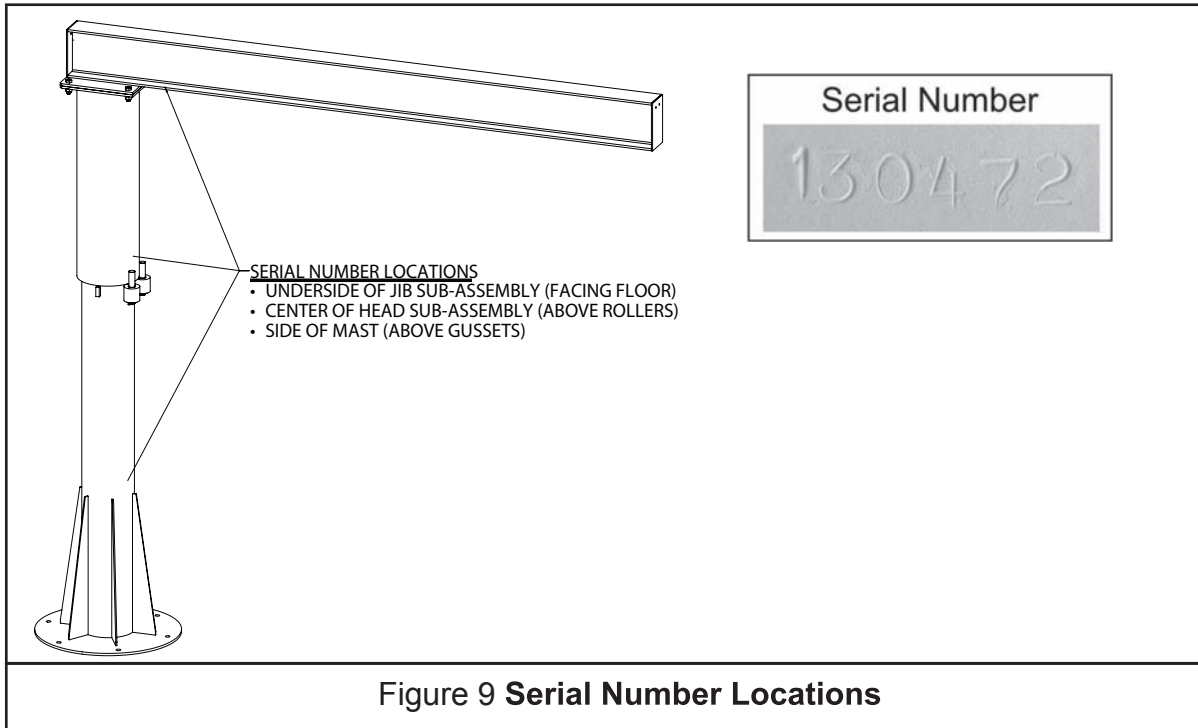

# Model 350/350F Parts Breakdown

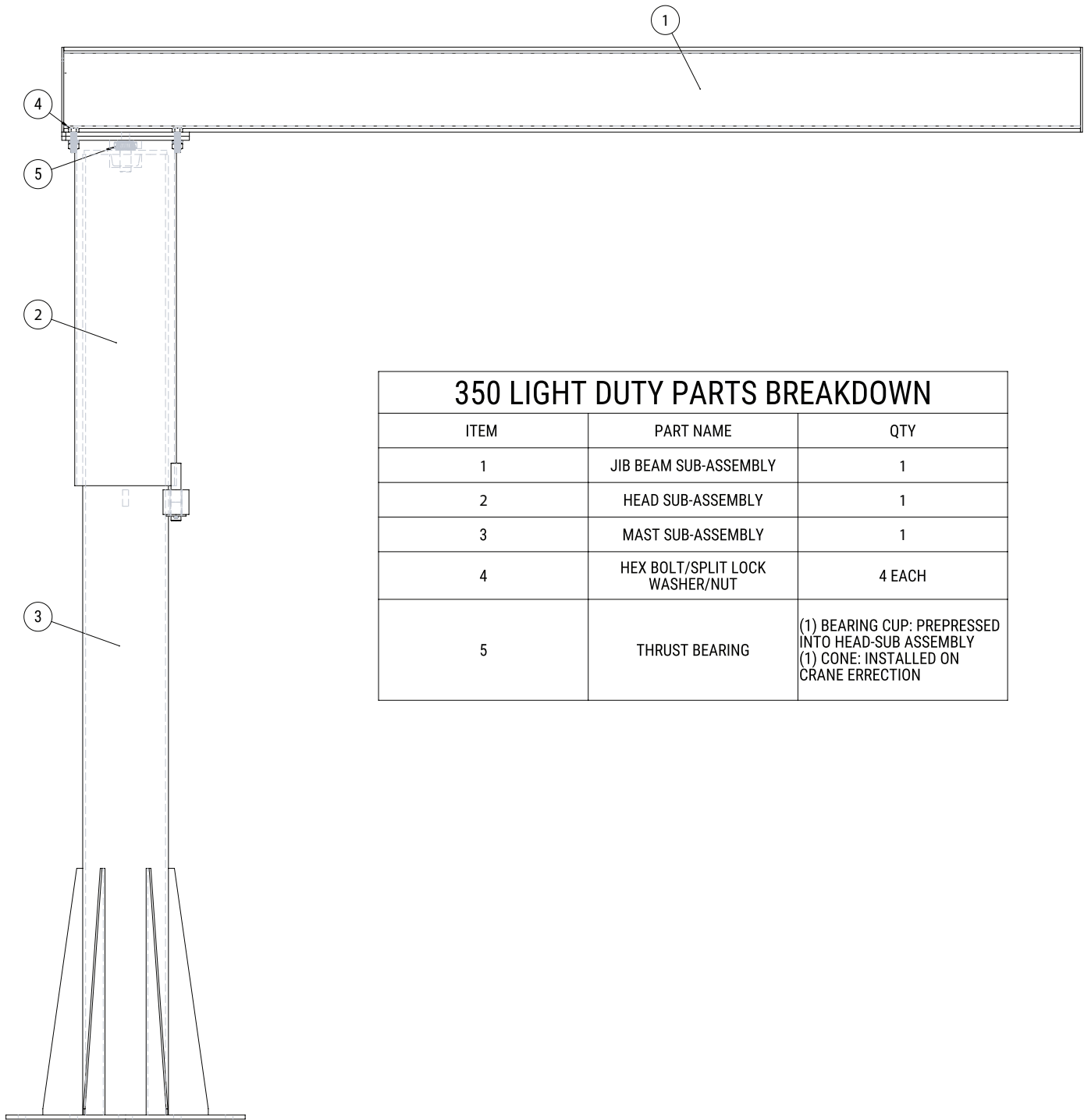

350 LIGHT DUTY PARTS BREAKDOWN		
ITEM	PART NAME	QTY
1	JIB BEAM SUB-ASSEMBLY	1
2	HEAD SUB-ASSEMBLY	1
3	MAST SUB-ASSEMBLY	1
4	HEX BOLT/SPLIT LOCK WASHER/NUT	4 EACH
5	THRUST BEARING	(1) BEARING CUP: PREPRESSED INTO HEAD-SUB ASSEMBLY (1) CONE: INSTALLED ON CRANE ERRECTION



**This Page Left Intentionally Blank**

**This Page Left Intentionally Blank**

**This Page Left Intentionally Blank**



[www.hsicrane.com](http://www.hsicrane.com)

Handling Systems Intl. Inc.  
8000 Joliet Rd.  
McCook, IL 60525

(888) 352-1213 Toll Free