



Read this Owner's Manual thoroughly before operating the equipment. Keep it with the equipment at all times. Replacements are available from Thern, Inc., PO Box 347, Winona, MN 55987, 507-454-2996. www.thern.com

IMPORTANT: Please record product information on page 2. This information is required when calling the factory for service.

ORIGINAL TEXT



 **FIRST MATE**

Owner's Manual

For
5PF5 Series
Portable Davit Cranes

Two-Year Limited Warranty

Please record the following:

Date Purchased: _____

Crane Model No.: _____

Crane Serial No.: _____

If sold with a winch:

Winch Model No.: _____

Winch Serial No.: _____

This information is required when calling the factory for service.

Thern, Inc. warrants its products against defects in material or workmanship for two years from the date of purchase by the original using buyer, or if this date cannot be established, the date the product was sold by Thern, Inc. to the dealer. To make a claim under this warranty, contact the factory for an RGA number. The product must be returned, prepaid, directly to Thern, Inc., 5712 Industrial Park Road, Winona, Minnesota 55987. The following information must accompany the product: the RGA number, the date of purchase, the description of the claimed defect, and a complete explanation of the circumstances involved. If the product is found to be defective, it will be repaired or replaced free of charge, and Thern, Inc. will reimburse the shipping cost within the contiguous USA.

This warranty does not cover any damage due to accident, misuse, abuse, or negligence. Any alteration, repair or modification of the product outside the Thern, Inc. factory shall void this warranty. This warranty does not cover any costs for removal of our product, downtime, or any other incidental or consequential costs or damages resulting from the claimed defects. This warranty does not cover brake discs, wire rope or other wear components, as their life is subject to use conditions which vary between applications.

FACTORY AUTHORIZED REPAIR OR REPLACEMENT AS PROVIDED UNDER THIS WARRANTY IS THE EXCLUSIVE REMEDY TO THE CONSUMER. THERN, INC. SHALL NOT BE LIABLE FOR ANY INCIDENTAL OR CONSEQUENTIAL DAMAGES FOR BREACH OF ANY EXPRESS OR IMPLIED WARRANTY ON THIS PRODUCT. EXCEPT TO THE EXTENT PROHIBITED BY APPLICABLE LAW, ANY IMPLIED WARRANTY OF MERCHANTABILITY OR FITNESS FOR A PARTICULAR PURPOSE ON THIS PRODUCT IS LIMITED IN DURATION TO THE DURATION OF THIS WARRANTY.

Some states do not allow the exclusion or limitation of incidental or consequential damages, or allow limitations on how long an implied warranty lasts, so the above limitation or exclusion may not apply to you. This warranty gives you specific legal rights, and you may also have other rights which vary from state to state.

Note: Thern, Inc. reserves the right to change the design or discontinue the production of any product without prior notice.

About This Manual

The Occupational Safety and Health Act of 1970 states that it is the employer's responsibility to provide a workplace free of hazard. To this end, all equipment should be installed, operated, and maintained in compliance with applicable trade, industrial, federal, state, and local regulations. It is the equipment owner's responsibility to obtain copies of these regulations and to determine the suitability of the equipment to its intended use.

This Owner's Manual, and warning labels attached to the equipment, are to serve as guidelines for hazard-free installation, operation, and maintenance. They should not be understood to prepare you for every possible situation.

The information contained in this manual is applicable only to the Thern First Mate Series Model 5PF5 Portable Davit Cranes. Do not use this manual as a source of information for any other equipment.

The following symbols are used for emphasis throughout this manual:

▲WARNING

Failure to follow 'WARNING!' instructions may result in equipment damage, property damage, and/or serious personal injury.

▲CAUTION

Failure to follow 'CAUTION!' instructions may result in equipment damage, property damage, and/or minor personal injury.

Important!

Failure to follow 'important!' instructions may result in poor performance of the equipment.

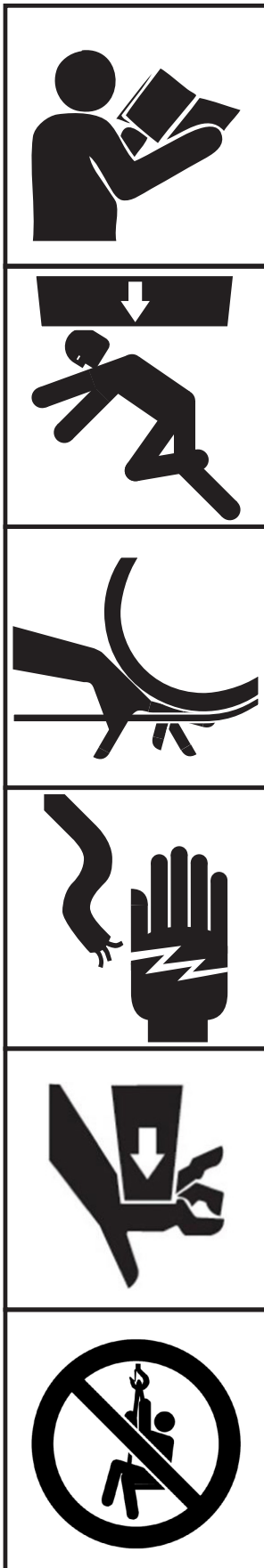

Suggestions for Safe Operation

⚠WARNING

DO the following:

Read and comply with the guidelines set forth in this Owner's Manual. Keep this manual, and all labels attached to the crane, readable and with the equipment at all times. Contact Thern, Inc. for replacements.

Check lubrication before use.

Install the wire rope securely to the winch drum.

Keep at least 4 wraps of wire rope wound on the drum at all times, to serve as anchor wraps. With less than 4 wraps on the drum the wire rope could come loose, causing the load to escape.

Keep hands away from sheaves, gears, wire rope, and other moving parts.

Disconnect electric power before servicing the equipment.

Keep all unnecessary personnel away from crane while in operation.

Keep out of the path of the load, and out of the path of a broken wire rope that might snap back and cause injury.

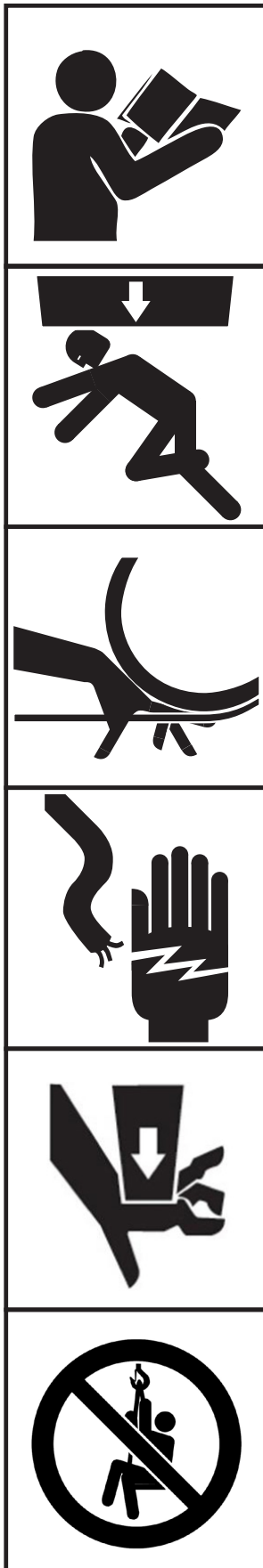

Suggestions for Safe Operation (cont.)

DO NOT do the following:

Do not lift people, or things over people. Do not walk or work under a load or in the line of force of any load.

Do not exceed the load rating of the crane or any other component in the system. To do so could result in failure of the equipment.

Do not use more than one crane to move a load that exceeds the load rating of a single crane. A shift in load weight could overload the equipment.

Do not use damaged or malfunctioning equipment. To do so could result in failure of the equipment.

Do not modify the equipment in any way. To do so could cause equipment failure.

Do not wrap the wire rope around the load. This damages the wire rope and could cause the load to escape. Use a sling or other approved lifting device.

Do not operate the crane with guards removed or improperly installed.

Do not divert your attention from the operation. Stay alert to the possibility of accidents, and try to prevent them from happening.

Do not jerk or swing the load. Avoid shock loads by starting and stopping the load smoothly. Shock loads overload the equipment and may cause damage.

Do not use the crane and winch components for any use other than for their original intended function.

Do not use the crane to drag or pull loads. This will create side pulls, which could damage the equipment or cause the load to tip.

Do not leave a suspended load unattended. Place the load on the ground if it must be left unattended.

Do not adjust the winch brake with the load suspended.

Do not operate or apply loads without all pins securely in place.

Do not adjust the boom angle while the crane is loaded.

1.1 Installing the Crane

Important!

- A qualified professional should inspect or design the foundation to insure that it will provide adequate support.
- Locate the crane so it will be visible during the entire operation.

⚠WARNING

Do not install the crane in an area defined as hazardous by the National Electric Code, unless installation in such an area has been thoroughly approved.

Do not install the crane near corrosive chemicals, flammable materials, explosives, or other elements that may damage the crane or injure the operator. Adequately protect the crane and the operator from such elements.

Position the crane so the operator can stand clear of the load, and out of the path of a broken wire rope that could snap back and cause injury.

Attach the crane to a rigid and level foundation that will support the crane and its load under all load conditions, including shock loading.

1.1.1 CONSULT APPLICABLE CODES AND REGULATIONS for specific rules on installing the equipment.

1.1.2 LOCATE THE CRANE in an area clear of traffic and obstacles that could interfere with operation. Make sure the crane is accessible for maintenance and operation.

1.1.3 INSTALL THE CRANE on a level surface. **An uneven surface may cause the boom to rotate in the direction the mast is leaning.**

1.1.4 FASTEN THE BASE securely to the foundation to withstand applicable overturning moments and mounting bolt reaction. See Table 1.

- a FOR STANDARD PRODUCTS referred to in this manual, use 1/2-inch coarse thread fasteners, grade 5 or better. Recommended torque for Grade 5 zinc plated bolts without lubrication is 65 ft-lb.

Refer to manufacturer's instructions for other fastener types with specific torque or installation instructions.

- b NON-STANDARD PRODUCTS that vary from the original design may have different fastening requirements. Contact a structural engineer or Thern, Inc. for this information.

TO COMPLY WITH LOCAL CODES, CONTACT A QUALIFIED PROFESSIONAL TO OBTAIN PROPER STRUCTURE OR FOUNDATION SPECIFICATIONS FOR THE MOUNTING OF THERN PRODUCTS.

Table 1 - Crane Reactions²

Crane Model	Mast Moment		Suggested Bolt Size	Pedestal Base		Wall Mount Base			
				Axial Force per Bolt ¹		Axial Force per Bolt ¹		Shear Force per Bolt	
5PF5	21,690 in-lbs	2,451 N-m	1/2 inch (M12)	2,060 lbs	9,164 N	1,460 lbs	6,495 N	1,150 lbs	5,116 N

1 Force in tension.

2 This information may change without prior notice. It is the responsibility of the installer and/or end user to ensure the most current information is used.

1.2 Assembling the Crane

Important!

- Inspect the crane during assembly according to the Instructions for Periodic Inspection. This will give you a record of the condition of the crane with which to compare future inspections.
- Save all boxes and crates that the crane was shipped in, use them again if you need to repack the crane.
- Contact the factory immediately if any parts are missing or damaged.
- Do not overtighten fasteners, this may strip threads or cause damage to other parts.

- 1.2.1 STUDY PARTS DRAWINGS to understand how the crane is assembled. See pages 20-22.
- 1.2.2 LUBRICATE PINS and other components prior to assembly. See Section 3.2 - Lubricating the Crane.
- 1.2.3 INSTALL THE BASE. See Section 1.1 for additional information and crane overturning moments and mounting bolt reaction forces.
- 1.2.4 INSTALL THE FLANGE BEARING in the base. Bearing must be set level on the base.
- 1.2.5 ASSEMBLE THE CRANE in the following order.
 - a FASTEN THE WINCH to the mounting plate using the fasteners provided. On some models you will need to use an additional winch adapter plate and fasteners provided to fasten the winch to the crane. **Make sure the winch is positioned correctly with the winch drum facing toward the load. See Figure 2.**
 - b INSTALL THE MAST in the base. Move the mast side-to-side to make sure the bottom of the mast properly seats on the pin in the bottom of the base. **The crane will not be stable unless properly seated.**
 - c FASTEN THE BOOM to the mast using the clevis pin and lynch pin provided. **Make sure the boom is positioned correctly.**
 - c INSTALL THE HANDLE using the winch clevis pin and lynch pin provided.

Figure 1 – Crane Packaging

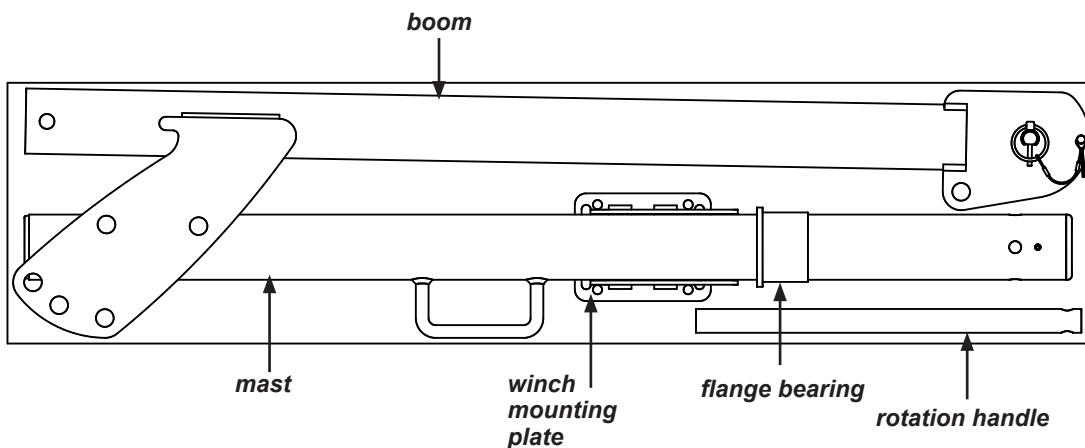

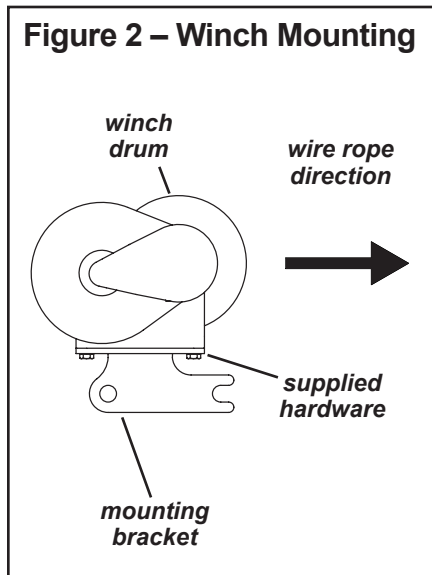

- d INSTALL THE WINCH onto the boom. Slide into position and secure with provided clevis pin and lynch pin.
- 1.2.6 INSTALL THE WINCH HANDLE on hand winches, or connect electric current on power winches. Refer to instructions in the Winch Owner's Manual.
- 1.2.7 INSTALL THE WIRE ROPE. **Use wire rope assemblies in the length specified on page 23.**
 - a REMOVE ROPE KEEPER PIN at the sheave to allow rope to be installed.
 - b PASS THE WIRE ROPE over the sheave at the end of the boom.
 - c REINSTALL ROPE KEEPER PIN to prevent the rope from escaping the sheave rope groove.
 - d ANCHOR THE WIRE ROPE to the winch drum and wind 4 wraps of wire rope onto the drum to act as anchor wraps. Refer to the instructions in the Winch Owner's Manual.
- 1.2.8 MAKE SURE ALL CLEVIS PINS ARE PROPERLY INSTALLED with all lynch pins in place to prevent components from shifting during use.
- 1.2.9 ADJUST BOOM ANGLE for the desired position.
- 1.2.10 INSTALL UPPER TRAVEL LIMIT SWITCH when supplied with power winches as directed in supplemental instructions provided with limit switch kit.

2.1 General Theory of Operation

Important!

- Limit nonuniform winding by keeping tension on the wire rope.
- It is your responsibility to detect and account for different factors affecting the condition and performance of the equipment.

- 2.1.1 THE INTENDED USE of this machinery is to lift and lower loads of its rated capacity or less. It is not for lifting people or things over people.
- 2.1.2 THE FORCE REQUIRED to lift the load must not exceed the load rating of the crane. Consider the total force required to lift the load, not the weight of the load.
- 2.1.3 THIS EQUIPMENT CAN develop forces that will exceed the load rating. It is the responsibility of the equipment user to limit the size of the load. Inspect the equipment regularly for damage according to the instructions contained in this manual.
- 2.1.4 PERFORMANCE RATINGS of the equipment are affected by the position of the boom and the amount of wire rope you use. **Crane load ratings decrease as you extend the reach.** See the Performance Characteristics Tables on page 23.
- a LOAD RATING represents the maximum force that can be placed on new equipment.
- b LIFT varies with the position of the boom and length of the wire rope configuration.
- c REACH varies with the position of the boom.
- 2.1.5 DUTY RATINGS refer to the type of use the equipment is subject to. Consider the following when determining duty rating.
- a ENVIRONMENT: harsh environments include hot, cold, dirty, wet, corrosive, or explosive surroundings. **Protect the equipment from harsh environments when possible.** Operating temperature range with manual winches is -40°F to +122°F. Operating temperature range for standard power winches is -4°F to 104°F.
- b MAINTENANCE: poor maintenance, meaning poor cleaning, lubrication, or inspection, leads to poor operation and possible damage of the equipment. **Minimize poor maintenance by carefully following the instructions contained in this manual.**
- c LOADING: severe loading includes shock loading and lifting loads that exceed the load rating of the equipment. **Avoid shock loads, and do not exceed the load rating of the equipment.**
- d FREQUENCY OF OPERATION: frequent or lengthy operations increase wear and shorten the life span of gears, bearings, sheaves, and other components. **Increase maintenance of the equipment if used in frequent operations.**
- 2.1.6 AIRBORNE NOISE EMISSIONS vary depending on load and the type of winch being used. Standard configurations do not typically exceed a sound pressure level of 80dB(A) at workstations.
- 2.1.7 VIBRATION LEVELS vary depending on load and type of winch being used. Standard configurations do not typically exceed vibration levels of 2.5 m/s².

CONTACT THE FACTORY FOR MORE INFORMATION.

2.2 Preparing for Operation

Important!

- When determining whether the load will exceed the load rating, consider the total force required to move the load.

⚠WARNING

Do not reposition the boom while the crane is under load.

- 2.2.1 **CONSIDER THE OPERATION.** Do not begin until you are sure you can perform the entire operation without hazard.
- 2.2.2 **INSPECT ALL COMPONENTS** of the system.
- INSPECT THE CRANE** and other equipment according to the Instructions for Frequent Inspection.
 - INSPECT THE WINCH** according to the instructions in the Winch Owner's Manual.
 - OPERATORS** must be in good health, alert, thoroughly trained in operating the equipment, and properly clothed (hard hat, safety shoes and safety glasses, no loose clothing).
 - THE LOAD** must be clear of other objects and free to move. Make sure the load will not tip, spin, roll away, or in any way move uncontrollably.
- 2.2.3 **KNOW YOUR LOAD** and make sure you do not exceed the load rating of the crane or any other equipment in the system.
- 2.2.4 **POSITION THE BOOM** so the load hook is centered over the load. **Avoid side pulls which could damage the crane or cause the load to tip.** See Figure 3.
- ADJUST BOOM ANGLE** by repositioning the clevis pin on the boom. **The lift height below base level decreases as you raise the boom.** See the Performance Characteristics Tables page 23.

Figure 3 – Positioning the Boom

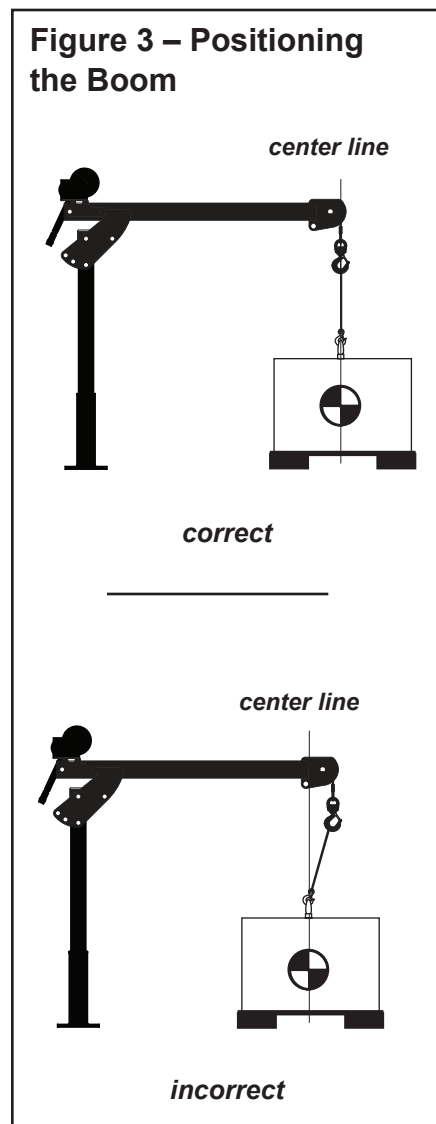

2.3 Attaching the Load

⚠ WARNING

Do not wrap the wire rope around the load. This damages the wire rope and could cause the load to escape. Use a sling or other approved lifting device.

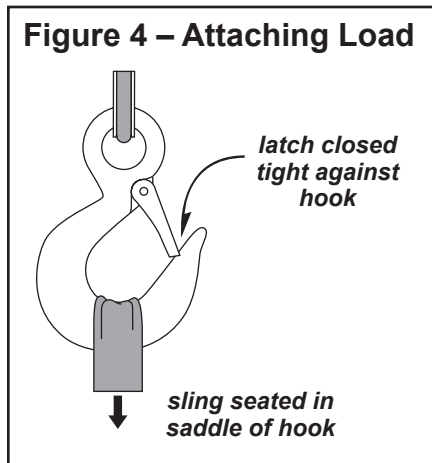

- 2.3.1 CLEAR OBJECTS from the path of the load so you can move it freely and observe it at all times during the operation.
- 2.3.2 MAKE SURE THE WIRE ROPE is not twisted. A twisted wire rope could cause the load to spin when it is raised off the ground.
- 2.3.3 ATTACH THE LOAD using a nylon sling, or other approved lifting device. Follow the recommendations of the sling manufacturer.
- SEAT THE SLING in the saddle of the hook with the hook latch completely closed. See Figure 4.
 - CENTER THE LOAD on the hook so it will remain balanced and not tip or rotate to one side.

2.4 Moving the Load

Important!

- Obey a stop signal from anyone.
- Maintain tension on the wire rope to keep it tightly and evenly wound on the drum.
- If the crane and load are not visible during the entire operation, get help from another person.
- Appoint a supervisor if more than one person is involved in the operation. This will reduce confusion and increase safety.
- When lifting a load, use a tag line to keep the load from swinging or twisting, while keeping yourself away from the load.

- 2.4.1 MOVE THE LOAD slowly and smoothly, only a small distance at first. Make sure the load is balanced and securely attached before continuing.
- 2.4.2 OPERATE THE WINCH to raise or lower the load. Refer to the instructions in the Winch Owner's Manual.
- 2.4.3 OBSERVE THE WIRE ROPE as it winds onto the drum. If it becomes loose, uneven, or overlapped, stop the operation and rewind the wire rope before continuing. **Continued operation with overlapped or uneven wire rope can damage the wire rope and shorten its life.**
- 2.4.4 ROTATE THE BOOM to move the load side-to-side.
- ROTATE THE BOOM slowly and smoothly to avoid swinging the load or causing shock loads. **Do not jam the boom against other objects.**
 - USE THE HANDLE to rotate the boom. **Do not push or pull the load or the wire rope to rotate the boom.**

3.1 Cleaning the Crane

Important!

Increase the frequency of maintenance procedures if the crane is:

- Operated for long periods.
- Used to lift heavy loads.
- Operated in wet, dirty, hot, or cold surroundings.

Clean the crane to remove dirt and help prevent rust and corrosion.

- 3.1.1 CLEAN THE CRANE every six months or whenever it is dirty.
- a WIPE ALL EQUIPMENT to remove dirt and grease.
 - b LEAVE A LIGHT FILM of oil on all surfaces to protect against rust and corrosion.
 - c WIPE OFF excessive amounts of oil to avoid the accumulation of dirt.
- 3.1.2 REMOVE UNNECESSARY OBJECTS from the area surrounding the crane.

3.2 Lubricating the Crane

Important!

- Make sure lubricant has a temperature rating appropriate for the ambient temperatures of the operation.

Lubricate the crane properly to help protect it from wear and rust. Read the following instructions carefully.

- 3.2.1 LUBRICATE ALL PINS before installation and at least every 3 months. Use a grease brush to apply a light film of NLGI #2 grease to all pins.
- 3.2.2 LUBRICATE THE WINCH. Refer to the Winch Owner's Manual for instructions.
- 3.2.3 LUBRICATE THE WIRE ROPE and other equipment by following the manufacturer's recommendations.

3.3 Disassembling the Crane

- 3.3.1 STUDY PARTS DRAWINGS to understand how the crane is assembled. See pages 20-22.
- 3.3.2 REMOVE ANY ATTACHED LOAD from the wire rope.
- 3.3.3 REMOVE THE WIRE ROPE
- REMOVE THE ROPE KEEPER PIN located at the end of the boom.
 - UNWIND THE ROPE from the winch drum and release the anchor.
 - REPLACE THE ROPE KEEPER PIN
- 3.3.4 REMOVE THE WINCH HANDLE on hand winches, or disconnect electric current on power winches. Refer to instructions in the Winch Owner's Manual.
- 3.3.5 REMOVE THE ROTATION HANDLE from the boom.
- 3.3.6 REMOVE THE WINCH and mounting bracket from the boom. Replace the clevis pin to prevent loss.
- 3.3.7 DISCONNECT THE BOOM from the mast.
- SECURE THE BOOM to prevent it from falling away when the pins are removed.
 - REMOVE THE LYNCH PIN AND CLEVIS PIN and carefully remove the boom.
 - REPLACE the clevis pin and lynch pin in the mast.
- 3.3.8 REMOVE THE MAST from the base by lifting it straight out of the base.
- 3.3.9 REMOVE THE BEARING from the base. Install a cap over the base to prevent debris and other contaminants from getting into the base.

3.4 Inspecting the Equipment

Important!

- Start an inspection program as soon as you put the crane into use.
- Appoint a qualified person to be responsible for regularly inspecting the equipment.
- Keep written records of inspection. This allows comparison with comments from previous inspections so you can see changes in condition or performance.

Perform frequent inspections:

- Before each operation.
- Every 3 hours during operation.
- Whenever you notice signs of damage or poor operation.

Frequent Wire Rope Inspection:

- Use ASME B30.7 as a guideline for rope inspection, replacement and maintenance.
- Check the wire rope, end connections and end fittings for corrosion, kinking, bending, crushing, birdcaging or other signs of damage.
- Check the number, distribution and type of visible broken wires. See paragraph 3.4.4 b and Figure 5.
- Check the wire rope for reduction of rope diameter from loss of core support, or wear of outside wires. See Figure 7.
- Take extra care when inspecting sections of rapid deterioration such as sections in contact with saddles, sheaves, repetitive pickup points, crossover points and end connections.

⚠WARNING

Do not use damaged or malfunctioning equipment. Place an “OUT OF ORDER” sign on the crane. Do not use the crane until the sign is removed by a qualified person who has completely corrected the problem.

Inspect the crane to detect signs of damage or poor operation before they become hazardous. See Table 2 Inspection Checklist.

3.4.1 CONSULT APPLICABLE CODES AND REGULATIONS for specific rules on inspecting the crane and other equipment.

3.4.2 REFER TO THE WINCH OWNER’S MANUAL for information regarding winch inspection.

3.4.3 Instructions for Frequent Inspection

a VISUALLY INSPECT the entire crane and all other equipment involved in the operation.

- Check all equipment for cracks, dents, bending, rust, wear, corrosion and other damage.
- Make sure the wire rope is installed correctly and anchored securely.
- Make sure the entire crane is properly lubricated.
- Make sure all fasteners are tight and secure.
- Make sure mounting fasteners are tightened securely.
- Make sure the foundation is in good condition, and capable of supporting the crane and its load under all load conditions.

b TEST CRANE PERFORMANCE by operating the crane with a load not exceeding the load rating.

- Listen for unusual noises, and look for signs of damage as you operate the crane.
- Make sure the wire rope winds evenly and tightly onto the drum. If it is loose or uneven, rewind it before continuing.
- Make sure the load moves smoothly, without hesitation or strain.
- On hand operated models, make sure the winch handle rotates freely in both directions.
- On power operated models, make sure the winch responds to the control device. It must rotate as shown on the control labels, and it must turn off when you release the control.
- Make sure the boom rotates freely when you push the handle, and remains stationary when you release it.
- Check the winch brake. Raise the load, then lower it and stop it a few feet off the ground. If the load continues to coast or creep under normal operating conditions, the brake may be worn and in need of repair or replacement. Contact the factory.

Completely correct all problems before continuing. Use the Troubleshooting Chart to help determine the cause of certain problems. See Table 3.

Perform periodic inspections:

- Every 6 months.
- Whenever you return the crane to service from storage.
- Whenever you notice damage or poor operation in a frequent inspection.
- Whenever you have, or think you may have, overloaded or shock loaded the crane.

Figure 5 – Broken Wires

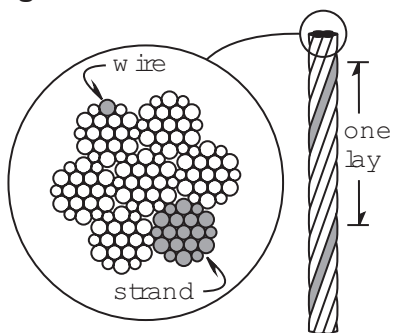

Wire rope assembly must be replaced if more than 6 wires are broken in one lay, or if more than 3 wires are broken in one strand in one lay.

Figure 6 – Load Hook Inspection

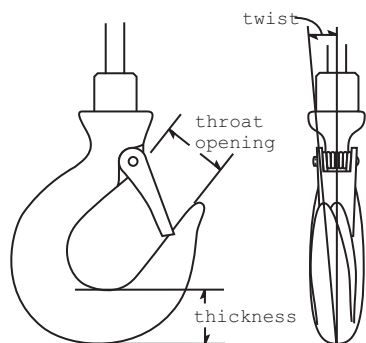

The wire rope assembly must be replaced if the throat opening is 15% wider than nominal, if the thickness is 10% less than nominal, or if the hook is twisted 10° or more.

3.4.4 Instructions for Periodic Inspection

- a VISUALLY INSPECT the crane and all other equipment.
 - Check the finish for wear, flaking, or other damage.
 - Check all equipment for cracks, dents, bending, rust, wear, corrosion and other damage. If the equipment was overloaded, or if you notice cracks and other signs of overloading and damage, promptly remove equipment from use and have it repaired or replaced. **DO NOT CONTINUE TO USE DAMAGED OR OVERLOADED EQUIPMENT OR WIRE ROPE.**
 - Check all fasteners for stripped threads, wear, bending, and other damage.
 - Make sure the entire crane is properly lubricated.
 - Make sure all labels and plates are readable, firmly attached, free of damage and clean. Replacements are available from the factory.
- b INSPECT THE WIRE ROPE according to the wire rope manufacturer's recommendations, or follow accepted industry standards for wire rope inspection.
 - Always wear protective clothing when handling wire rope.
 - Check the entire length of wire rope for bent wires, crushed areas, broken or cut wires, corrosion, and other damage. Carefully inspect areas that pass over sheaves or through roller guides.
 - Note the location and concentration of broken wires. Replace wire rope if more than 6 wires are broken in one lay, or more than 3 wires are broken in one strand in one lay. See Figure 5.
 - Make sure the load hook or other device is securely attached to the wire rope, and the wire rope where it is attached is not frayed, corroded, broken, or otherwise damaged.
 - Measure the throat opening, thickness, and twist of the hook. Replace the hook if it shows signs of damage. See Figure 6.
 - Make sure hook latch opens without binding and closes when released.
 - Check the anchor holes in the drum and the surrounding area for signs of wear or distortion.
- c PLACE enough weight to keep the wire rope straight and tightly drawn.
 - Measure the diameter of the wire rope, especially in areas where wear is noticeable. Replace the wire rope if the diameter measures below the minimum diameter at any point. See Figure 7.
- d REMOVE THE WINCH and inspect it by following the instructions in the Winch Owner's Manual.
- e DISASSEMBLE THE CRANE. Inspect each component for damage.
- f REMOVE THE CRANE BASE from the foundation.
 - Check fasteners for stripped threads, wear, bending, and other damage.
 - Check the foundation for cracks, corrosion, and other damage.

Figure 7 – Rope Diameter

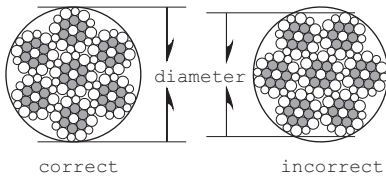

The wire rope assembly must be replaced if the diameter measures less than the minimum diameter at any point.

wire rope size	minimum diameter
1/8 in	7/64 in (.1094 in)
3/16 in	11/64 in (.1719 in)
1/4 in	15/64 in (.2344 in)

- g FASTEN THE CRANE BASE securely to the foundation.
- h REASSEMBLE THE CRANE.
- i TEST CRANE PERFORMANCE by operating the crane with a load equal to the load rating.
 - Listen for unusual noises, and look for signs of damage as you operate the crane.
 - Make sure the wire rope winds evenly and tightly onto the drum. If it is loose or uneven, rewind it before continuing.
 - Make sure the load moves smoothly, without hesitation or strain.
 - On hand operated models, make sure the winch handle rotates freely in both directions.
 - On power operated models, make sure the winch responds to the control device. It must rotate as shown on the control labels, and it must turn off when you release the control.
 - Make sure the boom rotates freely when you push the handle, and remains stationary when you release it.
 - Check the brake. Raise the load, then lower it and stop it a few feet off the ground. If the load continues to coast or creep under normal operating conditions, the brake may be worn and in need of repair or replacement. Contact the factory.

Completely correct all problems before continuing. Use the Troubleshooting Chart to help determine the cause of certain problems. See Table 3.

Table 3 – Troubleshooting Chart

problem	cause	correction
overheating	<ul style="list-style-type: none"> • operated too long without rest. • load too heavy • poor lubrication. • bearing seized up 	<ul style="list-style-type: none"> allow to cool lighten load inspect and lubricate as necessary inspect and replace as necessary
boom bounces up and down	<ul style="list-style-type: none"> • load too heavy • mounting bolts loose • sheave worn or damaged. • foundation loose or unlevel • winch gears worn or damaged 	<ul style="list-style-type: none"> lighten load tighten mounting bolts to proper torque inspect and replace as necessary inspect and repair as necessary inspect and repair as necessary
boom does not rotate	<ul style="list-style-type: none"> • rotation points contaminated or worn • flange bearing broken or locked. 	<ul style="list-style-type: none"> inspect and repair as necessary inspect and replace as necessary
boom rotates on its own	<ul style="list-style-type: none"> • foundation loose or unlevel • mast bent, distorted, or leaning. 	<ul style="list-style-type: none"> inspect and repair as necessary inspect and repair as necessary
unusual noises		
high pitched squeak	• poor lubrication.	lubricate entire crane properly
grinding noise	• contaminated lubricant at rotation points	clean and lubricate rotation points
rattling noise	• loose bolts, set screws or other fasteners.	tighten all bolts and other fasteners

Refer to the Winch Owner's Manual for possible problems with the winch and brake.

3.5 Repairing the Crane

Important!

- It is your responsibility to determine when to replace parts. When considering whether to continue using a part or to replace it, remember that replacing it is the best way to avoid further equipment damage.
- Appoint a qualified person to be responsible for all repairs to the equipment.

- 3.5.1 GET FACTORY AUTHORIZATION for all repairs. Unauthorized repairs will void the warranty, and may lead to damage or failure of the crane.
- 3.5.2 REPLACE DAMAGED OR POORLY OPERATING PARTS with Thern repair parts.
- 3.5.3 REFINISH AREAS where the paint is worn or flaking. A good finish helps to protect against corrosion and weather damage.
 - a REMOVE THE FINISH from damaged areas, down to the bare metal.
 - b CLEAN THE AREA thoroughly.
 - c REPAINT with a high quality primer and finishing coat.
- 3.5.4 TO ORDER REPAIR PARTS, contact your local dealer. Include the following information when ordering:
 - model number
 - serial number (or code number)
 - part number
 - date purchased, and from whom
 - description of what happened, or what is wrong
 - your name and return address

Table 4 – Crane Weight Chart

Component	Model 5PF5	
	LB	KG
Mast Assembly	23	10.4
Boom Assembly	31	14.1
Handle	2	0.9
TOTAL	56	25.4
Winch (including bracket)	LB	KG
M1 (M4022PB)	19	8.6
M3 (M4042PBSS)	26	11.8
M2 (4WM2-K)	40	18.1
E2 (4WP2-K)	74	33.6
E4 (4777-K)	96	43.6
E4DC (4777DC-K)	120	54.5

3.6 Field Test Procedure

▲CAUTION

Use the following instructions to perform a pre-service load test on new, undamaged, and unaltered equipment only. For field testing of existing in-service equipment, do not exceed 100% rated capacity.

- 3.6.1 VISUALLY INSPECT the product for any signs of wear, damage, or deformation. **Do not apply test loads until problems have been corrected.**
- 3.6.2 ASSEMBLE THE CRANE according to the instructions found within the owner's manual.
- 3.6.3 OPERATE THE CRANE, without load, through its designed range of motion. The product should operate smoothly, braking systems of power driven components operate effectively, and motion limiting devices are adjusted and functioning properly. **Do not continue until problems have been corrected.**
- 3.6.4 PREPARE A TEST LOAD with a load sensing device.
- 3.6.5 FOR MAXIMUM DYNAMIC LOAD TEST, load the crane to 110% of its rated capacity and operate the crane through its designed range of motion while checking for signs of damage.
 - a SLOWLY RELEASE THE LOAD and visually inspect the product for signs of wear, damage, or deformation. **Do not continue until problems have been corrected.**
- 3.6.6 FOR MAXIMUM STATIC LOAD TEST, load the crane to 125% of its rated capacity and hold for 10 minutes while checking for signs of damage. Do not exceed 125% of rated capacity.
 - a SLOWLY RELEASE THE LOAD and visually inspect the product for signs of wear, damage, or deformation. **Do not continue until problems have been corrected.**
- 3.6.7 OPERATE THE CRANE, without load, through its designed range of motion to confirm no failures.

Tests are considered successful if no fractures, permanent deformations, or damage affecting the function or safety of the crane are visible and if no connections have loosened or show signs of damage.

4.1 Transporting the Crane

Important!

- Keep a record of what you ship, and when you send it.

- 4.1.1 PARTIALLY DISASSEMBLE THE CRANE into components that can be transported.
- 4.1.2 PACK THE CRANE for transport, using the original packaging materials, if appropriate.
- 4.1.3 PACK THE WINCH for transport, using the original packaging materials, if appropriate. Please see the winch owner's manual for instructions.
- 4.1.4 REASSEMBLE THE CRANE at its new location following the instructions under Section 1.2 - Assembling the Crane.
- 4.1.5 INSPECT THE CRANE according to the Instructions for Frequent Inspection before installing it for operation. See Section 3.4.3 - Instructions for Frequent Inspection.

4.2 Storing the Crane

- 4.2.1 PARTIALLY DISASSEMBLE THE CRANE and store all parts in a cool clean place away from corrosive chemicals and moisture.
- 4.2.2 SEAL THE CRANE in plastic with a desiccant to help protect it from rust, corrosion, and other damage.
- 4.2.3 SEAL THE WINCH in plastic with a desiccant to help protect it from rust, corrosion, and other damage. Please see the winch owner's manual for instructions.
- 4.2.4 REASSEMBLE THE CRANE at its new location according to Section 1.2 - Assembling the Crane.
- 4.2.5 INSPECT THE CRANE according to Section 3.4.4 - Instructions for Periodic Inspection before installing it for operation.

Model 5PF5

Item	description	part number	qty.	material
1	MAST WELDMNT	B7371	1	SEE TABLE
2	BOOM WELDMNT	B7373	1	SEE TABLE
3	WELDMNT WINCH MOUNT 5Px5	B7378	1	SEE TABLE
4	HANDLE ROTATION 5Px5	B5825	1	SEE TABLE
5	PIN LINCH D ASSY - SEE PRINT	SEE TABLE	1	
6	PIN LINCH ASSY - LANYARD NOT SHOWN	SEE TABLE	3	
7	PIN CLEVIS .500 X 4.500 EFF LENGTH SST	B7383	1	
8	PIN CLEVIS .750 X 3.500 EFF LENGTH SST	B7384	2	
9	BRG FLNG 2.938ID X 3.50 OD X 1.75 NYLATRN	B7386	1	
10	BRG FLNG 0.500ID X 2.88 OD X 2.19 NYLATRN	B7387	1	
11	PIN SLOTTED SPRING .250 X .750 SST	A4290	2	
12	PLUG FINISH RND 2.750 X 10-14GA BLK	A14379	1	
13	SHEAVE ASSEMBLY	B2462	1	
14	PIN CLEVIS .750 DIA 5PT SHEAVE SST	A12314	1	
15	LABEL LOAD RATING 5PF5	B7331	1	
16	LABEL THERN 1.00 X 3.20	A6889	2	
17	LABEL FIRST MATE	B7326	2	
18	LABEL NAMEPLATE CRANES CE	A11529	1	
19	LABEL WARNING	B5790	1	
20	LABEL WARNING BEFORE LOADING	AB5791	1	

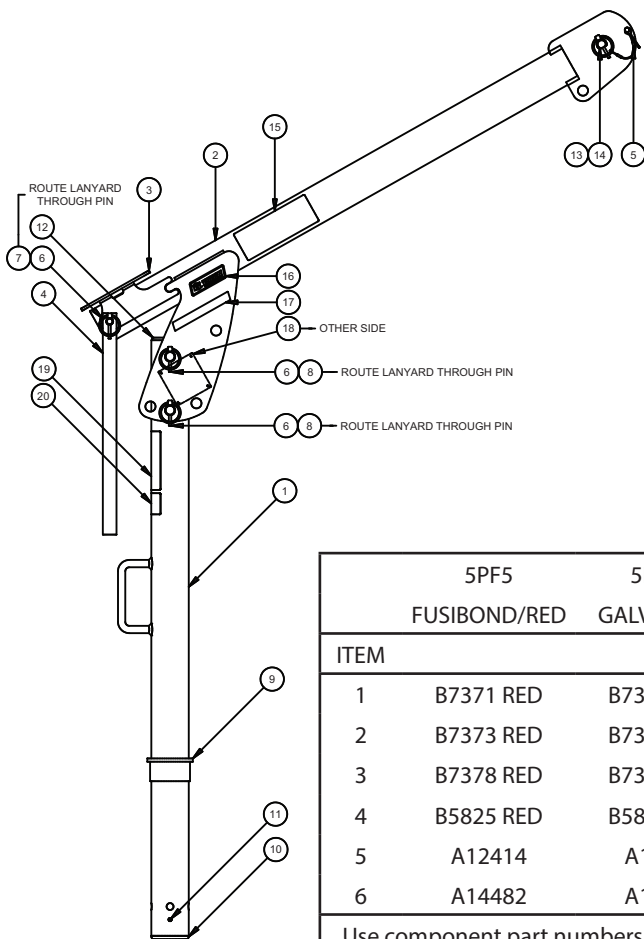

	5PF5	5PF5G	5PF5X	5PF5S	5PF5S316
	FUSIBOND/RED	GALVANIZED	EPOXY GRAY	STAINLESS	STAINLESS 316
ITEM					
1	B7371 RED	B7371 GAL	B7371 EGRA	B7371 SS	B7371 SS316
2	B7373 RED	B7373 GAL	B7373 EGRA	B7373 SS	B7373 SS316
3	B7378 RED	B7378 GAL	B7378 EGRA	B7378 SS	B7378 SS316
4	B5825 RED	B5825 GAL	B5825 EGRA	B5825 SS	B5825 SS316
5	A12414	A12414	A12414 SS	A12414 SS	A12414 SS
6	A14482	A14482	A14482 SS	A14482 SS	A14482 SS
Use component part numbers for material/finish that matches crane model number					
Example: Crane model 5PF5G uses components with part numbers XXXXXGAL.					

Pedestal Base		
5BP5 Series		
item	part no.	description
1	SEE TABLE	WELDMENT BASE 5BP5
2	5BC5	BASE COVER W/LANYARD
3	A14588	LABEL THERN

¹ When ordering parts, be sure to specify whether the finish is red, galvanized, epoxy or stainless.

	5BP5	5BP5G	5BP5X	5BP5S	5BP5S316
item					
1	B5821 RED	B5821 GAL	B5821 EGRA	B5821 SS	B5821 SS316

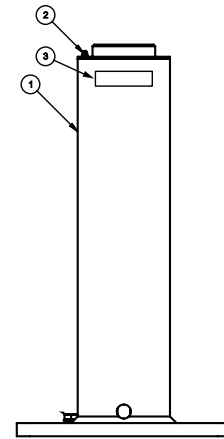

**5BP5
Pedestal Base**

Wall Base		
5BW5 Series		
item	part no.	description
1	SEE TABLE	WELDMENT BASE 5BW5
2	5BC5	BASE COVER W/LANYARD
3	A14588	LABEL THERN

¹ When ordering parts, be sure to specify whether the finish is red, galvanized, epoxy or stainless.

	5BW5	5BW5G	5BW5X	5BW5S	5BW5S316
item					
1	B5819 RED	B5819 GAL	B5819 EGRA	B5819 SS	B5819 SS316

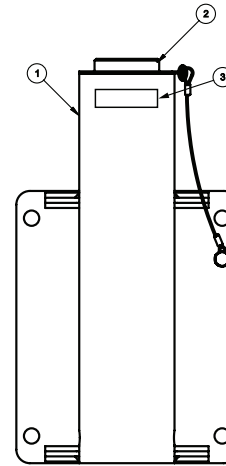

**5BW5
Wall Base**

Flush Base		
5BF5 Series		
item	part no.	description
1	SEE TABLE	WELDMENT BASE 5BF5
2	5BC5	BASE COVER W/LANYARD
3	A14588	LABEL THERN

¹ When ordering parts, be sure to specify whether the finish is red, galvanized, epoxy or stainless.

	5BF5	5BF5G	5BF5X	5BF5S	5BF5S316
item					
1	B5820 RED	B5820 GAL	B5820 EGRA	B5820 SS	B5820 SS316

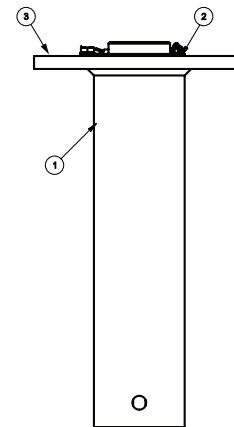

**5BF5
Flush Base**

Table 5 – Winch Part Numbers

	-M1	-M2	-M2X	-M3
description	part number	part number	part number	part number
MANUAL WINCH	M4022PB	4WM2-K	4WM2EGRA-K	M4042PBSS
	-E2	-E4	-E4DC	
description	part number	part number	part number	
ELECTRIC WINCH	4WP2-K	4777-K	4777DC-K	
ADAPTER PLATE		C3114	C5137	
	-E2X	-E4X	-E4DCX	
description	part number	part number	part number	
ELECTRIC WINCH	4WP2EGRA-K	4777EGRA-K	4777DCEGRA-K	
ADAPTER PLATE		C3114EGRA	C5137EGRA	

5PF5 Series Lift Below Floor² with Pedestal Base

Lift Below Floor ¹				Wire Rope Diameter		Wire Rope Length		Winch Configurations				
Minimum (C)		Maximum (A)						M1	M2	M3	E2	E4
(ft)	(m)	(ft)	(m)	(in)	(mm)	(ft)	(m)					
6	1.8	9	2.7	1/8	3	20	6.0	x	-	-	-	-
14	4.2	17	5.1	1/8	3	28	8.5	x	-	-	-	-
22	6.7	25	7.6	1/8	3	36	10.9	x	-	-	-	-
31	9.4	34	10.3	1/8	3	45	13.7	x	-	-	-	-
46	14.0	49	14.9	1/8	3	60	18.2	x	-	-	-	-
61	18.5	64	19.5	1/8	3	75	22.8	x	-	-	-	-
76	23.1	79	24.0	1/8	3	90	27.4	x	-	-	-	-
6	1.8	9	2.7	3/16	5	20	6.0	x	-	x	-	x
14	4.2	17	5.1	3/16	5	28	8.5	x	-	x	-	x
22	6.7	25	7.6	3/16	5	36	10.9	x	-	x	-	x
31	9.4	34	10.3	3/16	5	45	13.7	x	-	x	-	x
46	14.0	49	14.9	3/16	5	60	18.2	-	-	x	-	x
61	18.5	64	19.5	3/16	5	75	22.8	-	-	x	-	x
76	23.1	79	24.0	3/16	5	90	27.4	-	-	x	-	x
6	1.8	9	2.7	1/4	6	20	6.0	-	x	x	x	x
14	4.2	17	5.1	1/4	6	28	8.5	-	x	x	x	x
22	6.7	25	7.6	1/4	6	36	10.9	-	x	x	x	x
31	9.4	34	10.3	1/4	6	45	13.7	-	x	x	x	x
46	14.0	49	14.9	1/4	6	60	18.2	-	x	-	x	x
61	18.5	64	19.5	1/4	6	75	22.8	-	x	-	x	x

5PF5 Performance Ratings²

Boom Position	Load Rating ³ 1/8" Dia. wire rope		Load Rating ³ 3/16" and 1/4" Dia. wire rope		Hook Reach		Hook Height	
	(lb)	(kg)	(lb)	(kg)	(in)	(mm)	(in)	(mm)
A	500	226	500	226	42	1066	40	1016
B	570	258	600	272	35	889	60	1524
C	570	258	850	385	24	609	70	1778

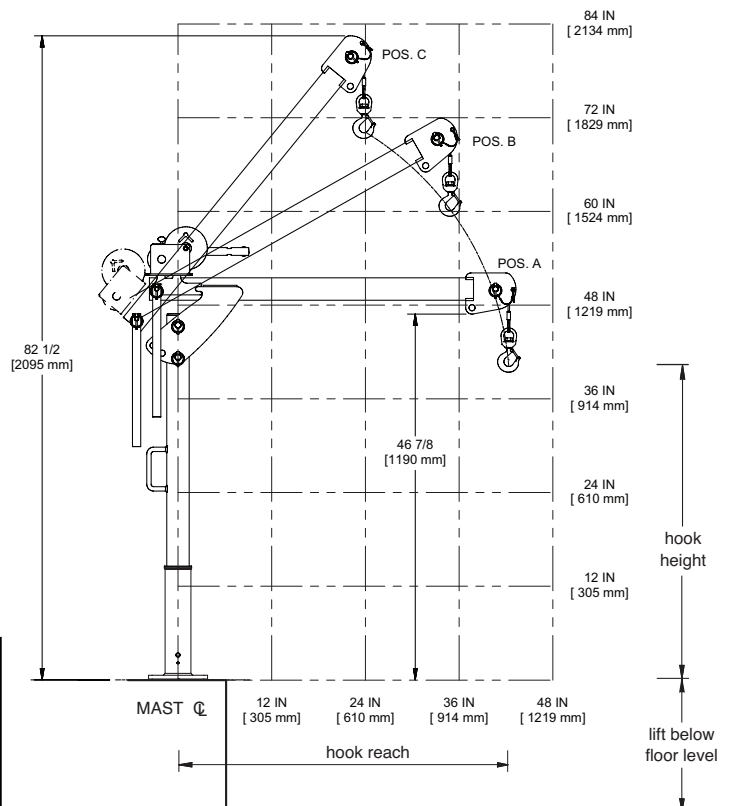

IMPORTANT:

It is the owner or operator's responsibility to determine the suitability of the equipment to its intended use. Study all applicable codes, manuals and regulations. Be sure to read the Owner's Manual supplied with the equipment before operating it.



Thern, Incorporated
Corporate Headquarters & Mfg.
5712 Industrial Park Road
Winona, MN USA
1-800-843-7648
Phone: 1-507-454-2996
Email: info@thern.com
www.thern.com

Thern Europe BV
Regional Headquarters
Siriusdreef 17-27, 2132 WT
Hoofddorp
The Netherlands
Phone: +31-546-898-380
europe@thern.com