

ADJUSTABLE WORK-MATE STAND, ALUMINUM - AHW-H-1936-A

*** ANY ADDITIONS, DELETIONS, OR OMISSIONS MUST BE CORRECTED ON THIS DRAWING AS THIS DRAWING WILL BE CONSIDERED ALL INCLUSIVE ***
 ALL GRAPHICS PROVIDED ARE FOR REFERENCE ONLY. IF CERTAIN DIMENSIONS ARE CRITICAL PLEASE VERIFY THOSE DIMENSIONS WITH YOUR SALESPERSON

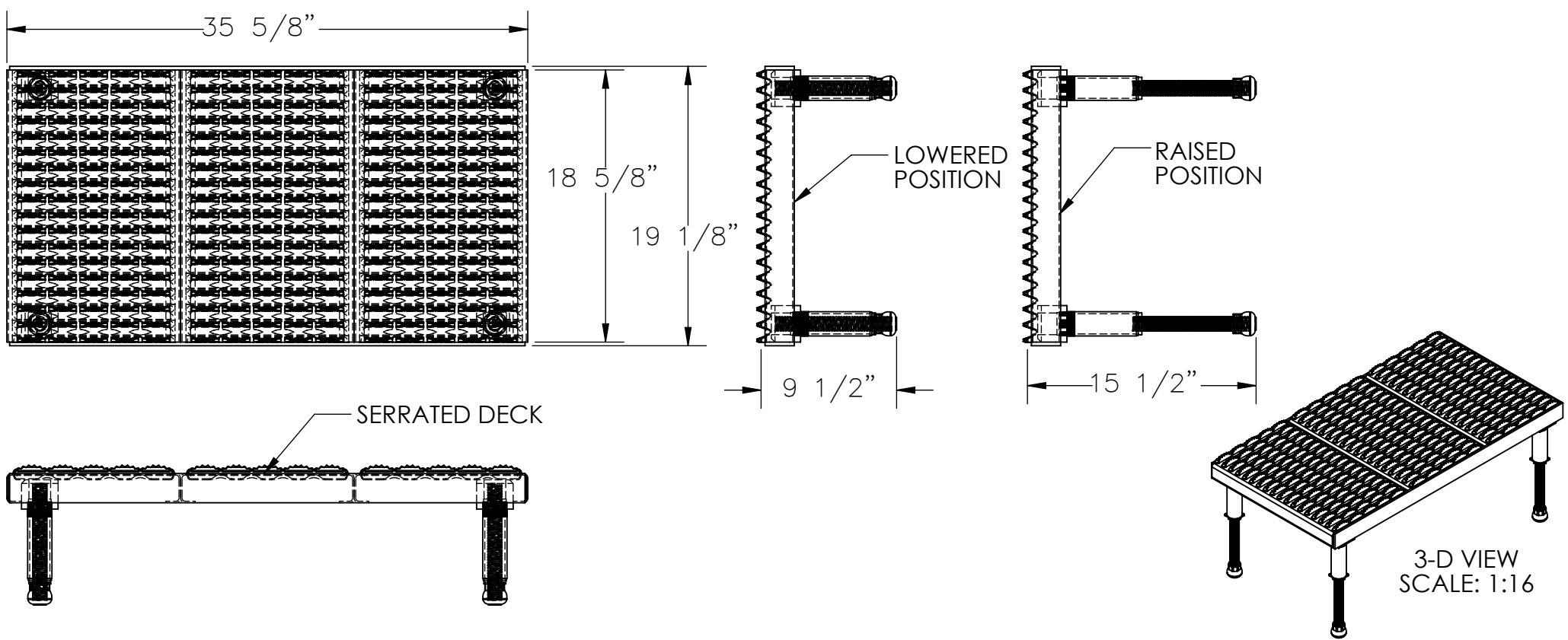

STANDARD FEATURES

- MODEL NUMBER: AHW-H-1936-A
- CAPACITY: 500 LBS. EVENLY DISTRIBUTED
- PLATFORM SURFACE: SERRATED
- PLATFORM SIZE: 19 1/8" W x 35 5/8" L
- PLATFORM SERVICE RANGE: 9 1/2" - 15 1/2"
- ALUMINUM PLATFORM WITH POWDERCOATED
- STEEL LEGS AND RUBBER CRUTCH TIPS ON LEGS

SPECIAL FEATURES

NONE

APPROX WEIGHT: 41.49 lbs.
 DOES NOT INCLUDE WEIGHT OF POWER OR PACKAGING!!!

A P P R O V A L	I, THE UNDERSIGNED, AGREE THAT THE PRODUCT AS REPRESENTED SATISFIES DESIGN AND DIMENSION REQUIREMENTS. I ALSO ACKNOWLEDGE MY DUTY TO CONFIRM PRODUCT AND INSTALLATION COMPLIANCE WITH ALL APPLICABLE FEDERAL, STATE AND LOCAL REGULATIONS AND STANDARDS.	
	ALL SPECIAL UNITS ARE NON-RETURNABLE	
	[] As drawn [] As marked	
Signed: _____		Date: _____
LEAD TIME WILL START UPON RECEIPT OF SIGNED APPROVAL DRAWING		

DISTRIBUTOR'S NAME:		P.O.#
VESTIL MANUFACTURING		X
DRAWN BY: BJW		W.O.#
DATE: 5/21/2012		X
REFERENCE: X	SCALE: 1:10	SALES: X
QUOTED LEAD TIME: X	QUOTE # X	FILE NAME:
		14-007-140