

ALUMINUM PALLET - AP-3624

APPROX WEIGHT: 24.39 lbs.
DOES NOT INCLUDE WEIGHT OF POWER OR PACKAGING!!!

*** ANY ADDITIONS, DELETIONS, OR OMISSIONS MUST BE CORRECTED ON THIS DRAWING AS THIS DRAWING WILL BE CONSIDERED ALL INCLUSIVE ***
ALL GRAPHICS PROVIDED ARE FOR REFERENCE ONLY. IF CERTAIN DIMENSIONS ARE CRITICAL PLEASE VERIFY THOSE DIMENSIONS WITH YOUR SALESPERSON

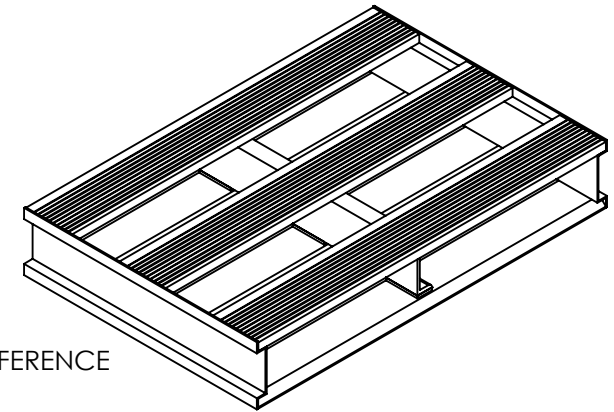
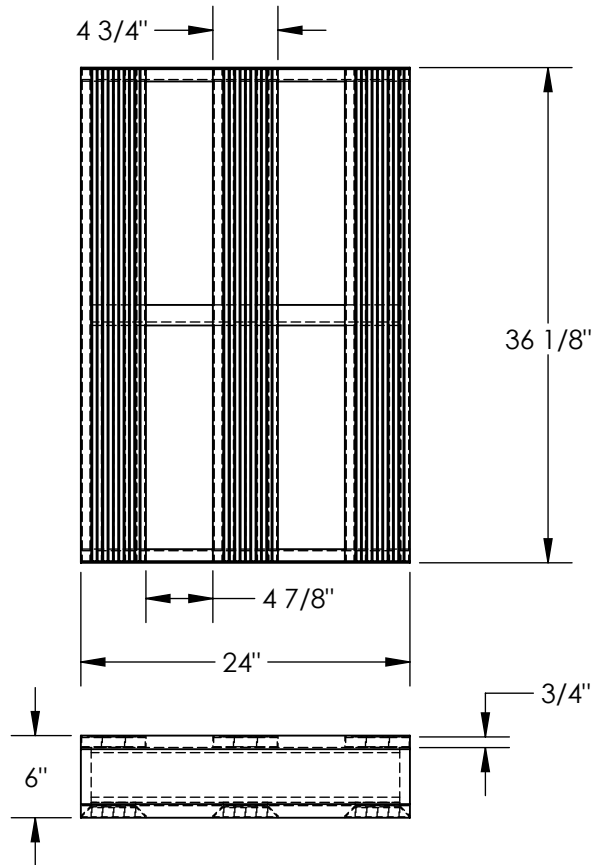

3D VIEW FOR REFERENCE

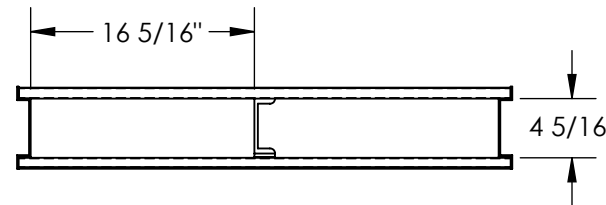

DIMENSION TOLERANCE $\pm 1/4"$

STANDARD FEATURES

- MODEL NUMBER IS AP-3624
- ALL WELDED ALUMINUM CONSTRUCTION
- OVERALL WIDTH IS 36 1/8"
- OVERALL DEPTH IS 24"
- OVERALL HEIGHT IS 6"
- THICKNESS OF EXTRUSIONS IS 3/4"
- MAX. CAPACITY IS 4,000 LBS
- EVENLY DISTRIBUTED
- FORK OPENINGS ARE 16 5/16"W x 4 5/16"H

SPECIAL FEATURES

NONE

APPROVAL	I, THE UNDERSIGNED, AGREE THAT THE PRODUCT AS REPRESENTED SATISFIES DESIGN AND DIMENSION REQUIREMENTS. I ALSO ACKNOWLEDGE MY DUTY TO CONFIRM PRODUCT AND INSTALLATION COMPLIANCE WITH ALL APPLICABLE FEDERAL, STATE AND LOCAL REGULATIONS AND STANDARDS.	
	UNITS REQUIRING APPROVAL DRAWINGS OR MODIFIED ARE NON-RETURNABLE	
	[] As drawn [] As marked	
	Signed: _____	Date: _____
Printed Name: _____		
<i>LEAD TIME WILL START UPON RECEIPT OF SIGNED APPROVAL DRAWING</i>		

FOR INTERNAL USE ONLY PROJECT SIGN OFF		DISTRIBUTOR'S NAME:		P.O.#			
		VESTIL MANUFACTURING		X			
SALES		DRAWN BY:	MTS	DATE:	10/14/20	W.O.#	X
ENG.		REFERENCE:	X	SCALE:	1:14	SALES:	X
FAB.		QUOTED LEAD TIME:	X	QUOTE #	X	FILE NAME:	
POWER							31-007-333