

MANUAL CAROUSEL WITH TOP PLATE - CA-48-2-TP-SSM

ANY ADDITIONS, DELETIONS, OR OMISSIONS MUST BE CORRECTED ON THIS DRAWING AS THIS DRAWING WILL BE CONSIDERED ALL INCLUSIVE

APPROX WEIGHT: 211.36 lbs.
DOES NOT INCLUDE WEIGHT OF POWER OR PACKAGING!!!

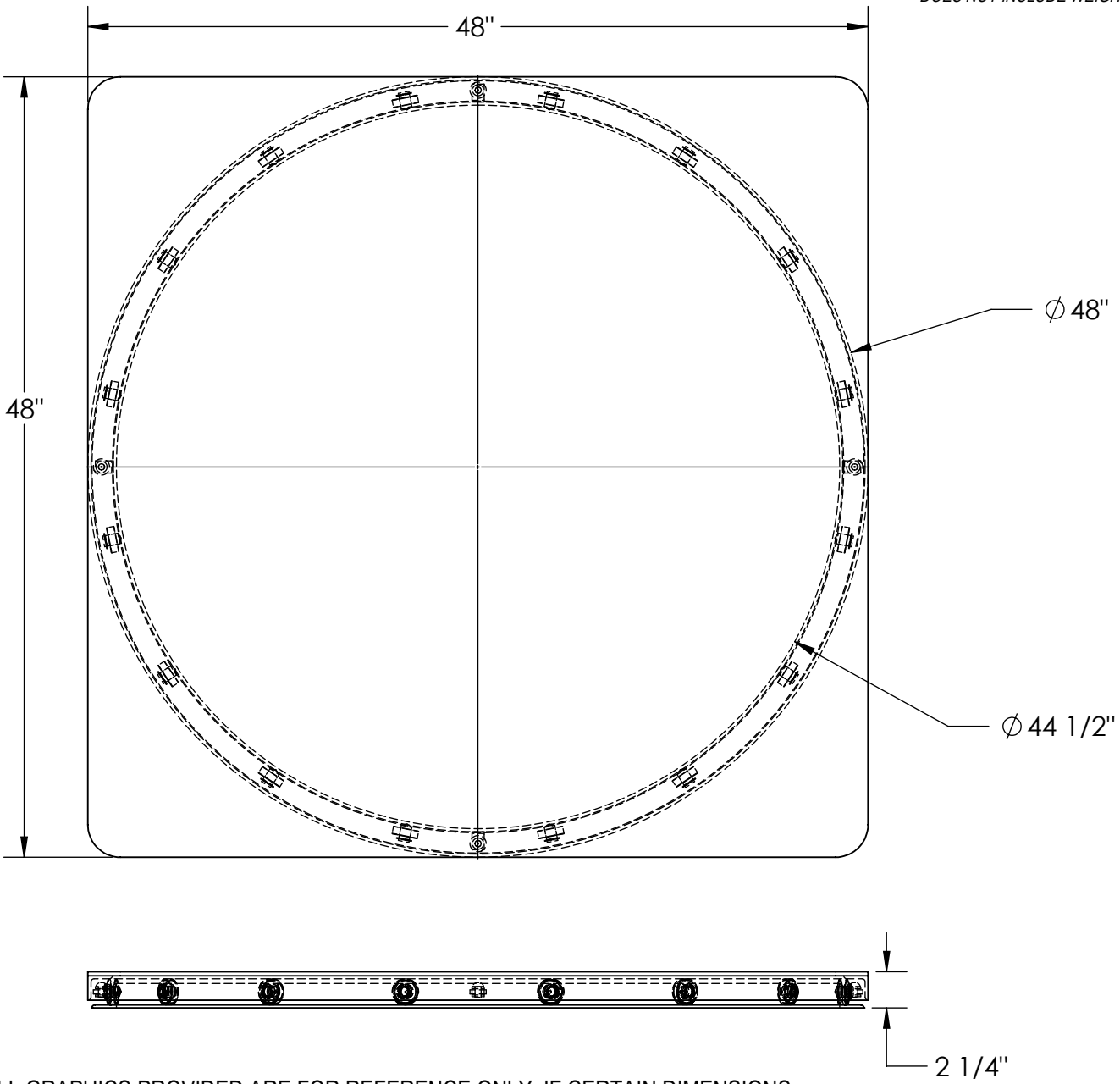

ALL GRAPHICS PROVIDED ARE FOR REFERENCE ONLY. IF CERTAIN DIMENSIONS ARE CRITICAL PLEASE VERIFY THOSE DIMENSIONS WITH YOUR SALESPERSON

DIMENSION TOLERANCE $\pm 1/4"$

STANDARD FEATURES

- MODEL NUMBER: CA-48-2-TP-SSM
- CAPACITY: 2,000 LBS
- LEVEL HEIGHT: 2 1/4"
- DIAMETER: 48"
- NUMBER OF BEARINGS: 16
- FEATURES SQUARE SMOOTH TOP PLATE
- TOP PLATE IS 48" x 48"
- DURABLE LIQUID PAINT BLUE FINISH

SPECIAL FEATURES

NONE

A P P R O V A L	I, THE UNDERSIGNED, AGREE THAT THE PRODUCT AS REPRESENTED SATISFIES DESIGN AND DIMENSION REQUIREMENTS. I ALSO ACKNOWLEDGE MY DUTY TO CONFIRM PRODUCT AND INSTALLATION COMPLIANCE WITH ALL APPLICABLE FEDERAL, STATE AND LOCAL REGULATIONS AND STANDARDS.	
	UNITS REQUIRING APPROVAL DRAWINGS OR MODIFIED ARE NON-RETURNABLE	
	[] As drawn [] As marked	
	Signed: _____	Date: _____
Printed Name: _____		
LEAD TIME WILL START UPON RECEIPT OF SIGNED APPROVAL DRAWING		

DISTRIBUTOR'S NAME:		P.O.#
VESTIL MANUFACTURING		X
DRAWN BY: TJM		DATE: 09/26/22
DATE: 09/26/22		SALES: X
REFERENCE: X	SCALE: 1:10	FILE NAME:
QUOTED LEAD TIME: X	QUOTE # X	20-007-246