

MANUAL CAROUSEL WITH TOP PLATE - CA-60-4-TP-SSM

ANY ADDITIONS, DELETIONS, OR OMISSIONS MUST BE CORRECTED ON THIS DRAWING AS THIS DRAWING WILL BE CONSIDERED ALL INCLUSIVE

APPROX WEIGHT: 316.79 lbs.
DOES NOT INCLUDE WEIGHT OF POWER OR PACKAGING!!!

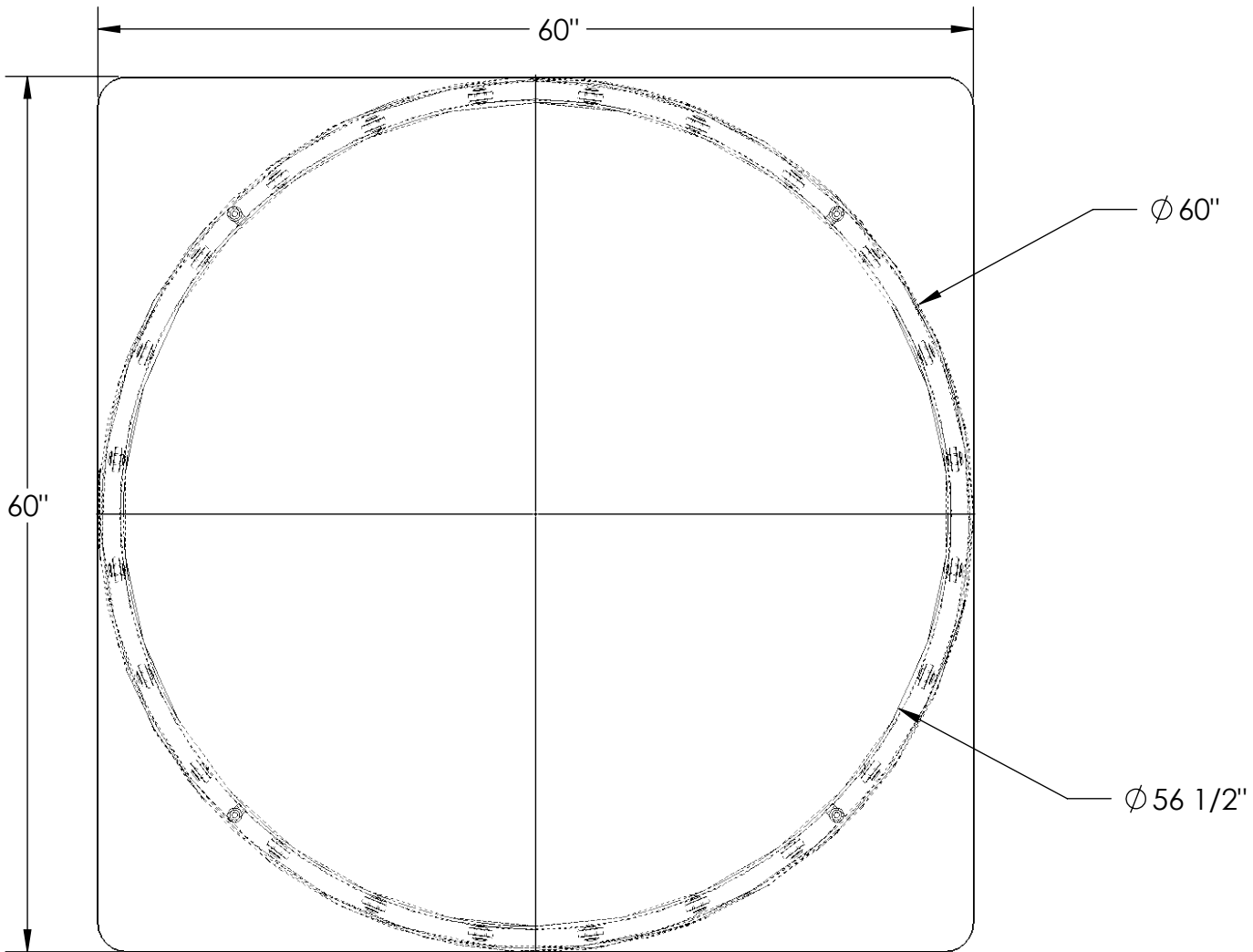

ALL GRAPHICS PROVIDED ARE FOR REFERENCE ONLY. IF CERTAIN DIMENSIONS ARE CRITICAL PLEASE VERIFY THOSE DIMENSIONS WITH YOUR SALESPERSON

DIMENSION TOLERANCE $\pm 1/4"$

STANDARD FEATURES

- MODEL NUMBER: CA-60-4-TP-SSM
- CAPACITY: 4,000 LBS
- LEVEL HEIGHT: 2 1/4"
- DIAMETER: 60"
- NUMBER OF BEARINGS: 24
- FEATURES SQUARE SMOOTH TOP PLATE
- TOP PLATE IS 60" x 60"
- DURABLE LIQUID PAINT BLUE FINISH

SPECIAL FEATURES

NONE

APPROVAL

I, THE UNDERSIGNED, AGREE THAT THE PRODUCT AS REPRESENTED SATISFIES DESIGN AND DIMENSION REQUIREMENTS. I ALSO ACKNOWLEDGE MY DUTY TO CONFIRM PRODUCT AND INSTALLATION COMPLIANCE WITH ALL APPLICABLE FEDERAL, STATE AND LOCAL REGULATIONS AND STANDARDS.
UNITS REQUIRING APPROVAL DRAWINGS OR MODIFIED ARE NON-RETURNABLE
[] As drawn [] As marked

Signed: _____ Date: _____

Printed Name: _____

LEAD TIME WILL START UPON RECEIPT OF SIGNED APPROVAL DRAWING

DISTRIBUTOR'S NAME:		P.O.#
VESTIL MANUFACTURING		X
DRAWN BY: TJM		DATE: 09/26/22
DATE: 09/26/22		SALES: X
REFERENCE: X	SCALE: 1:12	FILE NAME:
QUOTED LEAD TIME: X	QUOTE # X	20-007-262