

# ALUMINUM PALLET DOLLY - DOL-ST-4248-6NT

APPROX WEIGHT: 61.84 lbs.  
 DOES NOT INCLUDE WEIGHT OF POWER OR PACKAGING!!!

\*\*\*ANY ADDITIONS, DELETIONS, OR OMISSIONS MUST BE CORRECTED ON THIS DRAWING AS THIS DRAWING WILL BE CONSIDERED ALL INCLUSIVE\*\*\*

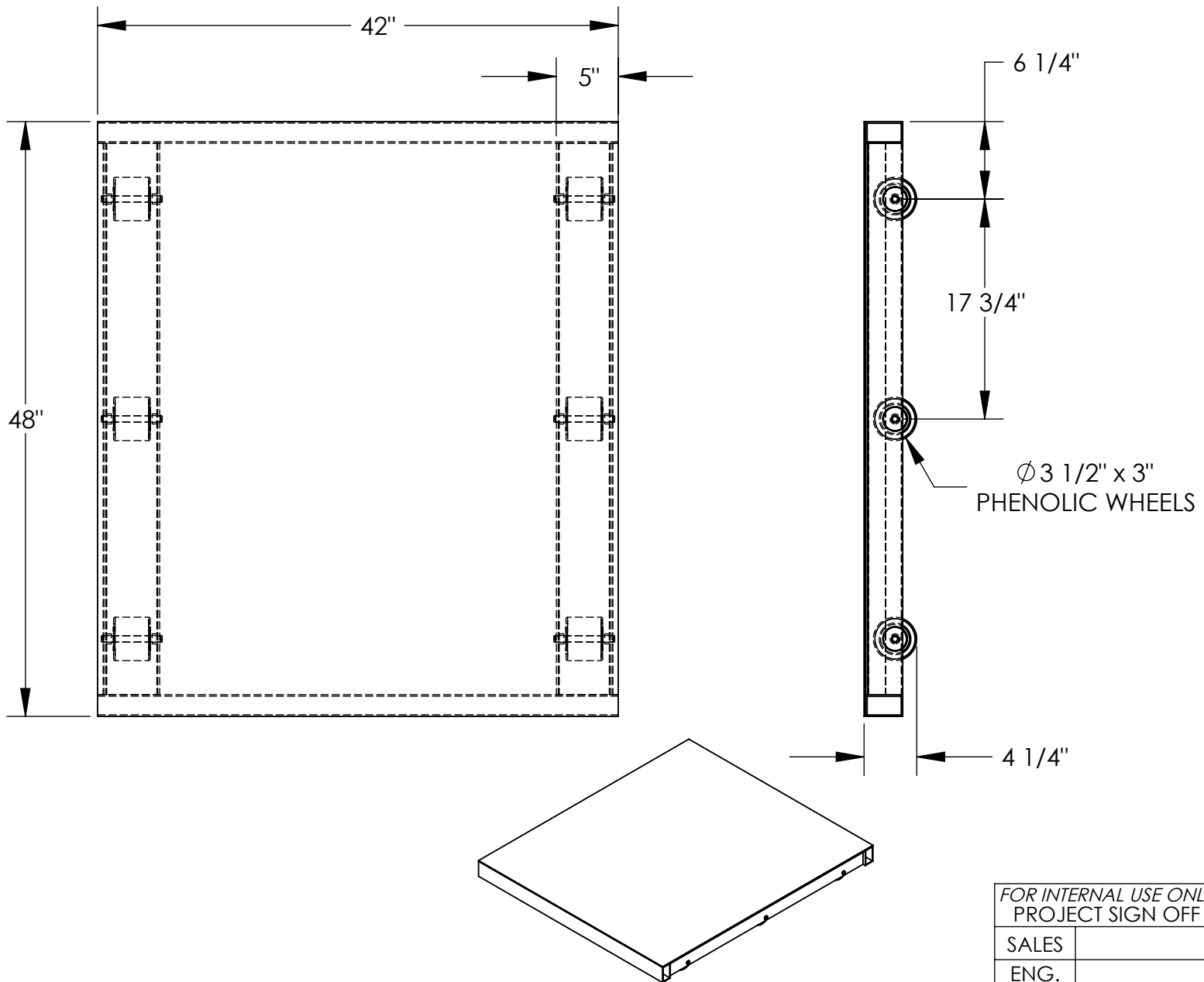

FOR INTERNAL USE ONLY PROJECT SIGN OFF	
SALES	
ENG.	
FAB.	
POWER	

ALL GRAPHICS PROVIDED ARE FOR REFERENCE ONLY. IF CERTAIN DIMENSIONS ARE CRITICAL PLEASE VERIFY THOSE DIMENSIONS WITH YOUR SALESPERSON

## STANDARD FEATURES

- MODEL NUMBER IS DOL-ST-4248-6NT
- CAPACITY IS 4,000 LBS.
- OVERALL WIDTH IS 42"
- OVERALL LENGTH IS 48"
- OVERALL HEIGHT IS 4 1/4"
- 6 ROLLERS Ø 3 1/2" x 3", PHENOLIC
- NON-TILT STYLE
- ALUMINUM CONSTRUCTION

## SPECIAL FEATURES

NONE

<b>A P P R O V A L</b>	I, THE UNDERSIGNED, AGREE THAT THE PRODUCT AS REPRESENTED SATISFIES DESIGN AND DIMENSION REQUIREMENTS. I ALSO ACKNOWLEDGE MY DUTY TO CONFIRM PRODUCT AND INSTALLATION COMPLIANCE WITH ALL APPLICABLE FEDERAL, STATE AND LOCAL REGULATIONS AND STANDARDS.	
	<b>ANY MODIFIED UNITS ARE NON-RETURNABLE</b>	
	[ ] As drawn      [ ] As marked	
	Signed: _____ Date: _____	
Printed Name: _____		
<i>LEAD TIME WILL START UPON RECEIPT OF SIGNED APPROVAL DRAWING</i>		

DISTRIBUTOR'S NAME:		P.O.#
<b>VESTIL MANUFACTURING</b>		X
		W.O.#
DRAWN BY: NBE		X
DATE: 4/24/2020		SALES: X
REFERENCE: X	SCALE: 1:12	FILE NAME:
QUOTED LEAD TIME: X	QUOTE # X	16-007-486