

ELECTRIC HYDRAULIC LIFT TABLE PORTABLE - EHLTP-3664-3-60-D2

APPROX WEIGHT: 1132 lbs.
DOES NOT INCLUDE WEIGHT OF POWER OR PACKAGING!!!

*** ANY ADDITIONS, DELETIONS, OR OMISSIONS MUST BE CORRECTED ON THIS DRAWING AS THIS DRAWING WILL BE CONSIDERED ALL INCLUSIVE ***
ALL GRAPHICS PROVIDED ARE FOR REFERENCE ONLY. IF CERTAIN DIMENSIONS ARE CRITICAL PLEASE VERIFY THOSE DIMENSIONS WITH YOUR SALESPERSON

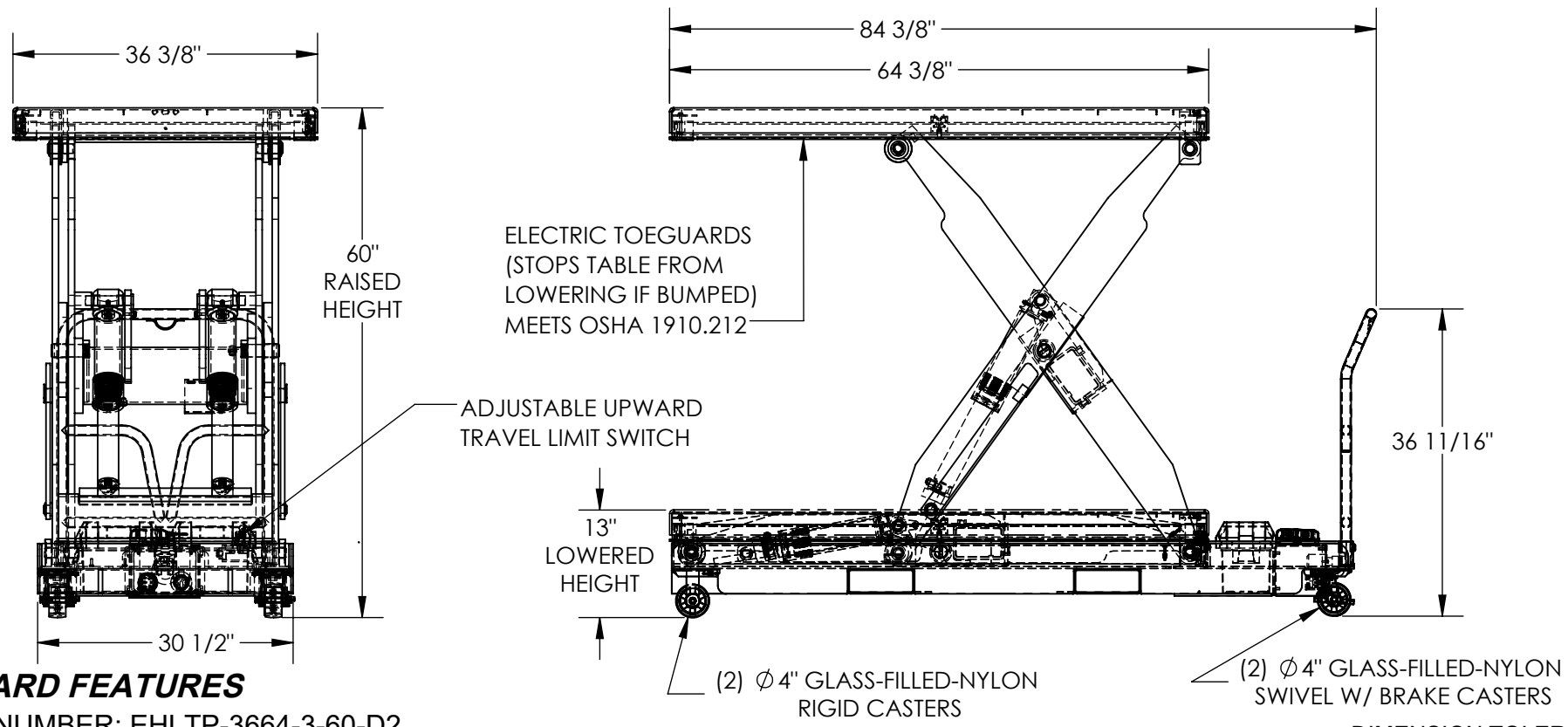

STANDARD FEATURES

- MODEL NUMBER: EHLTP-3664-3-60-D2
- DECK WIDTH: 36 3/8"
- DECK LENGTH: 64 3/8"
- OVERALL LENGTH: 84 3/8"
- RAISED HEIGHT: 60"
- LOWERED HEIGHT: 13"
- MAX CAPACITY: 3,000 LBS.
- TABLE CAPACITY (EVENLY DISTRIBUTED)
- CONTROL IS HANDHELD 2 BUTTON, NEMA 4
- PENDANT WITH MINIMUM 8' USABLE COIL CORD
- INTERNAL POWER UNIT
- SAFETY MAINTENANCE PROPS, DISPLACEMENT
- STYLE CYLINDERS INSTALLED ROD DOWN
- EMERGENCY SAFETY STOP HYDRAULIC FUSES
- IN ALL CYLINDERS
- DURABLE LIQUID PAINT BLUE FINISH
- 12V DC WITH ONBOARD 115 CHARGER

SPECIAL FEATURES

NONE

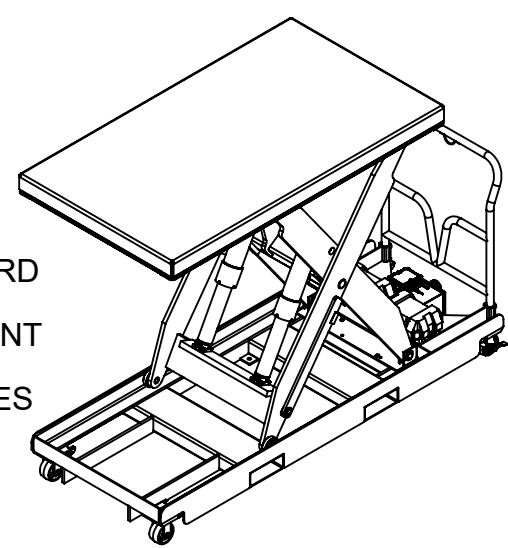

DIMENSION TOLERANCE ± 1/4"

APPROVAL	I, THE UNDERSIGNED, AGREE THAT THE PRODUCT AS REPRESENTED SATISFIES DESIGN AND DIMENSION REQUIREMENTS. I ALSO ACKNOWLEDGE MY DUTY TO CONFIRM PRODUCT AND INSTALLATION COMPLIANCE WITH ALL APPLICABLE FEDERAL, STATE AND LOCAL REGULATIONS AND STANDARDS.	
	UNITS REQUIRING APPROVAL DRAWINGS OR MODIFIED ARE NON-RETURNABLE	
	[] As drawn [] As marked	
	Signed: _____ Date: _____	
Printed Name: _____		
LEAD TIME WILL START UPON RECEIPT OF SIGNED APPROVAL DRAWING		

DISTRIBUTOR'S NAME:		P.O.#
VESTIL MANUFACTURING		X
DRAWN BY: CRA	DATE: 02/24/2021	W.O.#
REFERENCE: X	SCALE: 1:20	X
QUOTED LEAD TIME: X	QUOTE #	SALES: X
	X	FILE NAME:
		01-007-490