

MANUAL SWEEPER GUIDE

Model JL550S

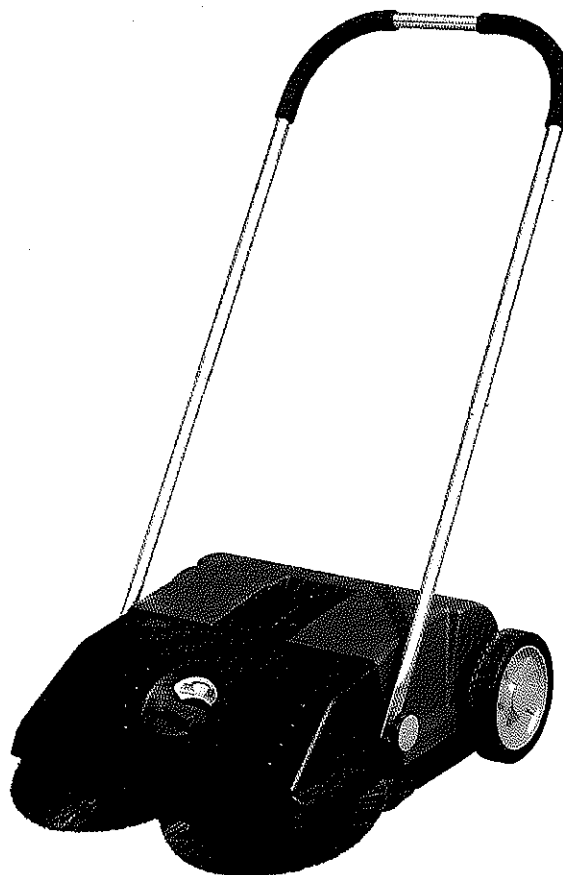

Please make sure you read the instruction manual below and clear the operation before you use this sweeper.

STANDARD PRODUCTS AND SPARE PARTS IN THE BOX

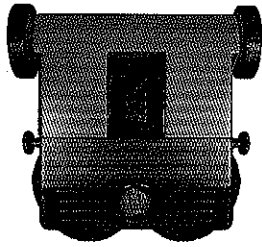

Sweeper body
Turning knob 2pcs

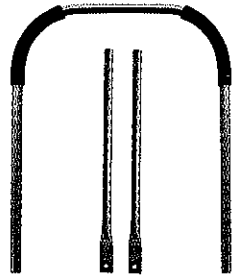

Tube handel 1 set

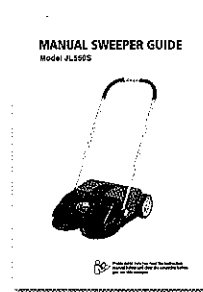

Instruction manual 1pcs

The spare parts item No. mentioned below please refer to the explosion drawing.

ASSEMBLY

HANDEL TUBE ASSEMBLY

1. TUBE HANDLE ASSEMBLY

Insert the sliding handle(3) into the tube adjustable handle(2) and let the stop spring (34) stuck into the hole, then assembly done.



Sliding handle



Tube adjustable handle

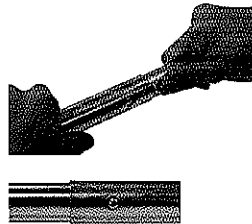

2. ASSEMBLE TUBE HANDEL TO THE SWEEPER BODY

Connect the sliding handle hole to the screw on the side of the sweeper body and screw up the turning knob(5);

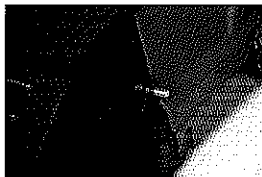

CONTAINER DETACH AND ASSEMBLY

1. Detach the container

Lift the container handle (4) and release it.

Lightly pull off the container

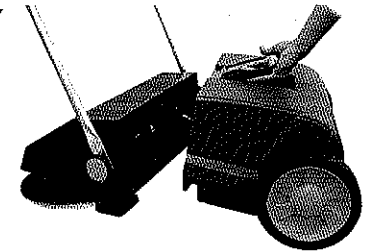

2. Container Assembly

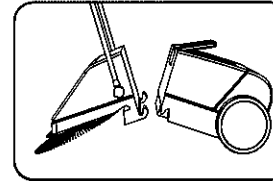

Step 1:

1. Lift the container handle and release it;
2. Lift the front part and the container part to a certain angle and make the two parts to a V shape;

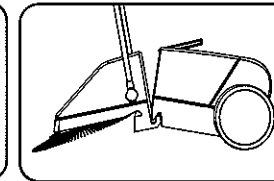

Step 2:

1. Connect the hook parts of the front body with the groove parts of the back container body to an perfect connecting level;

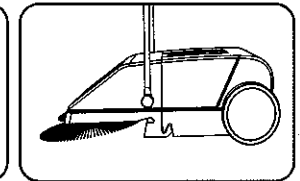

Step 3:

1. Combine the front parts and the container body together;
2. Push down the container handle to lock it;

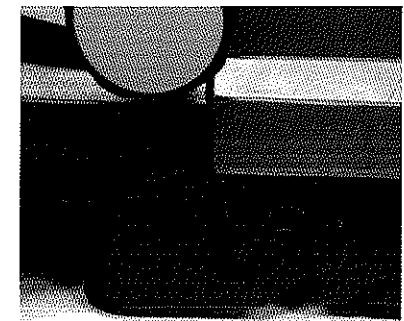
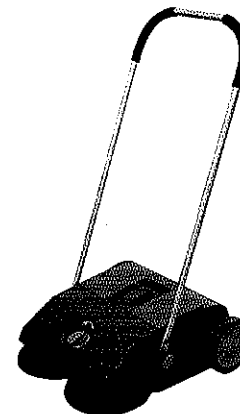
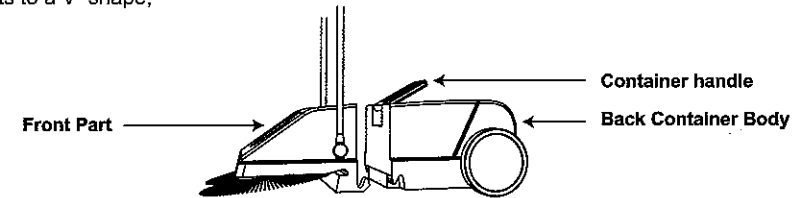

OPERATION



1. Hand push action. Extremely easy to use. Normal walking speed recommended.
2. Suitable for wet and dry use including sawdust, metal filings, leaves, stones, cigarette butts, papers, cans, cups, broken glass, large debris, sand and dirt.
3. Works on all surfaces including workshops, driveways, walkways, store fronts, patios, garages, pool side;
4. While sweeping the carrying capacity of the waste container can be maximized by lifting the front to allow the waste to fall to the back the container;
5. When sweeping small traces of fine dust may remains in the middle of the sweeping machine, this should be cleaned regularly for best result.
6. The surface should be competitive flat with no big pit.

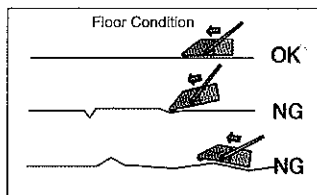

EMPTYING WASTE CONTAINER

Detach the container, and empty the container waste into trash can.

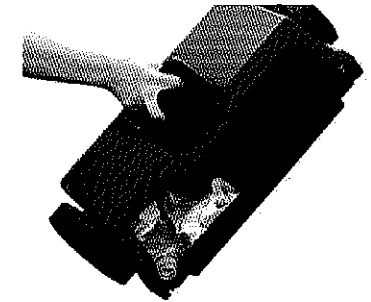
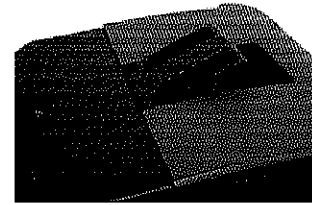

BRUSH ADJUSTMENT

The adjustment knob for the circular broom is located on the front.

Turn right to lower. Turn left to raise.

Step 1-2 for new brooms, all even, hard floors like asphalt, concrete or tiles.

Step 3-4 for new brooms, wet leaves, sand, uneven floors like exposed aggregate or concrete tiles.

Step 5-8 for older brooms, or very uneven ground.

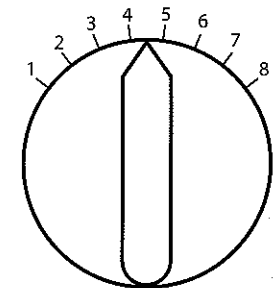
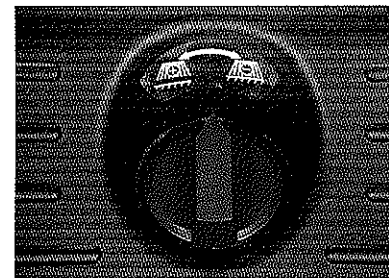

BRUSH (CIRCULAR BROOM) REPLACEMENT

1. Set the adjusting turning knob to the far right side;

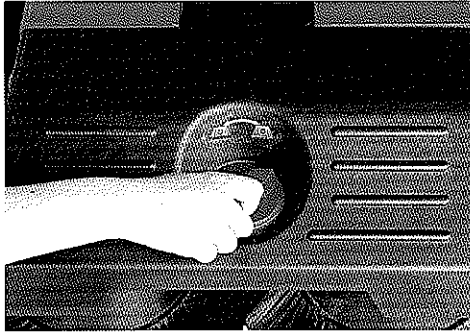

2. Pull the inclined wheels (15 /16) strongly and remove it with the axle (13 14).

Keep note of the left and right wheels as they must be replaced on same side for normal operation;

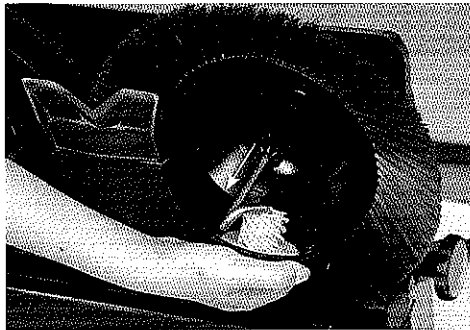

3. Pull out the circular broom together with the toothed sleeve.

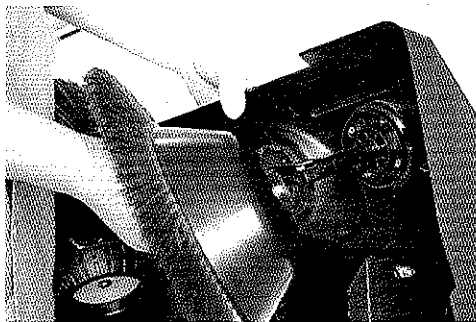

4. Remove the toothed sleeve.

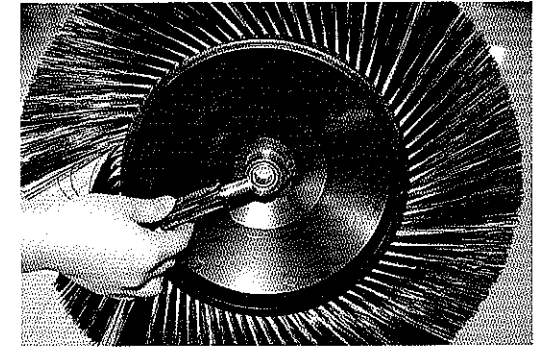

5. Insert the toothed sleeve into the replacement brush

6. Reinsert the brush and ensure it is completely seated into the rod housing.

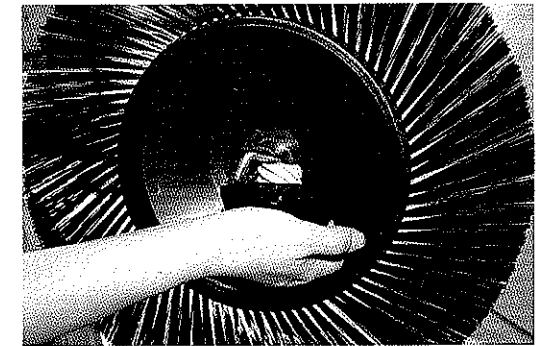

7. Reinsert the inclined wheel and axel into the rod. Firmly push until the assembly pops into position.

MAINTENANCE

The broom could be clean with water. Avoid hot water or heat air blowing.

Sweeper body could be clean with water. Avoid have it under the blazing sunlight for long time.

Spool cords, thread must removed for best result.

EXPLOSION DRAWING

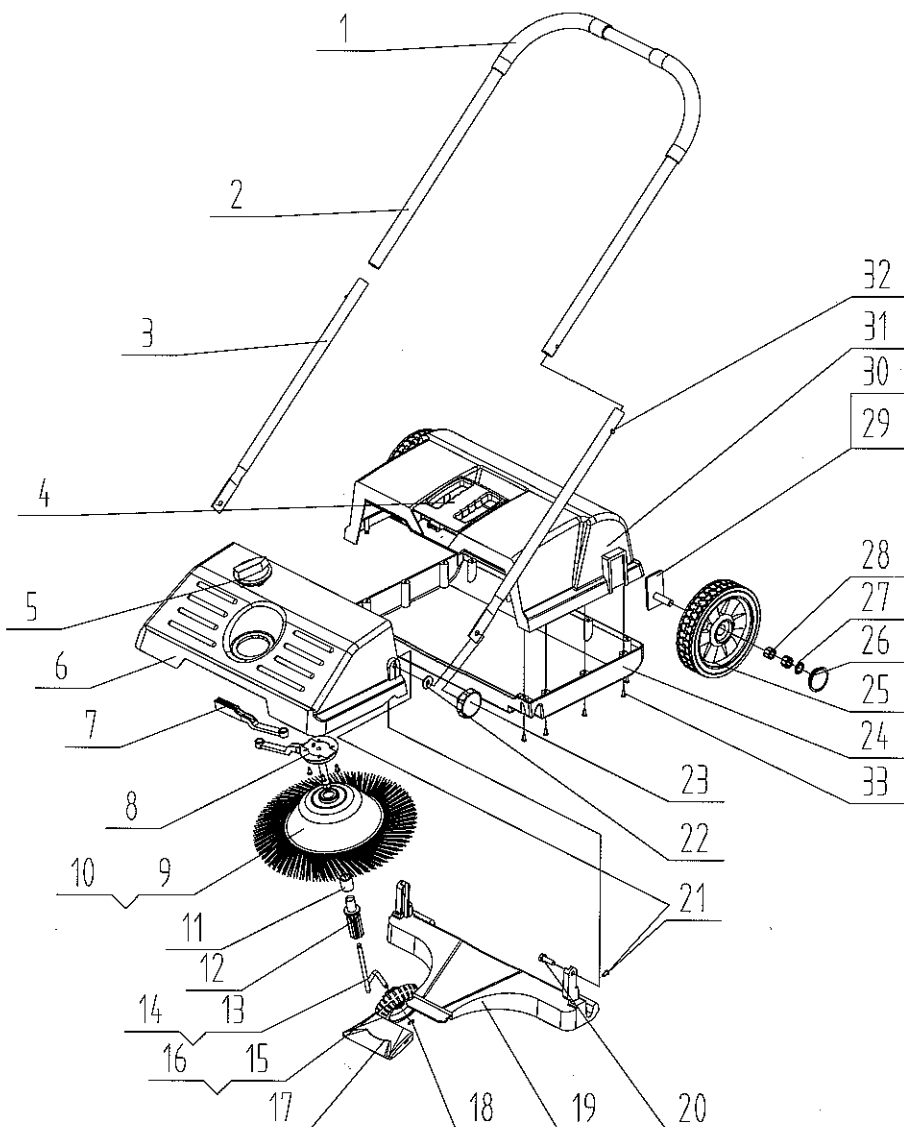

1. Handle grip	1	19. Collecting plate	1
2. Tube Adjustable Handle	1	20. Bolt M8X30	2
3. Sliding handle parts	2	21. Screw ST4X8	2
4. Container handle	1	22. PU washer	2
5. Turning knob	1	23. Turning knob	2
6. Front cover	1	24. Container	1
7. Adjusting Bar	2	25. Wheel complete	2
8. Axle cover	2	26. Wheel cap	2
9. Left circular broom	1	27. Quick-fastener 11.5	2
10. Right circular broom	1	28. Axle cover	4
11. Bearing 1626	2	29. Axle left welding part	1
12. Toothed bushing	2	30. Axle right welding part	1
13. Axle left	1	31. Container cap	1
14. Axle right	1	32. Stop spring	2
15. Right inclined wheel	1	33. Screw ST4X16	21
16. Left inclined wheel	1		
17. Holder ground board	1		
18. Washer 6	2		

STORAGE

When working done, fold the tube handle flat to make the sweeper vertical like and hang it on the wall to save storage space.

Please make sure the sweeper is well hanged and avoid dropping and hurt people, pets and other things.

When take down the sweeper, please do it carefully to avoid dropping the handle or sweeper body to the ground and causing damage.

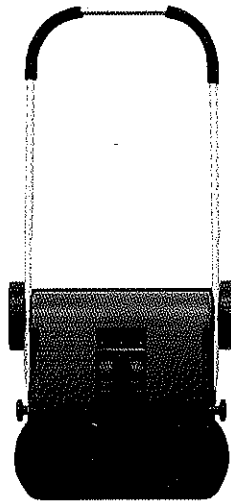
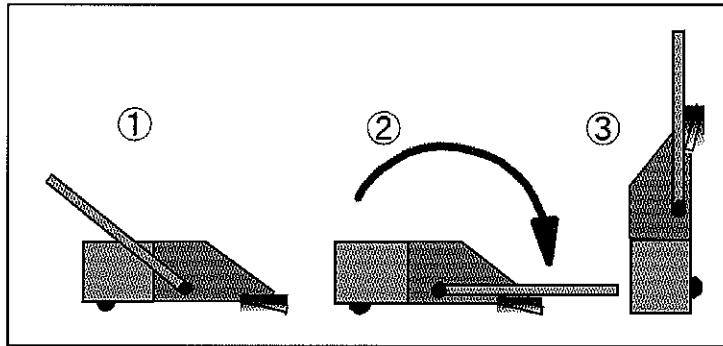

PROBLEM TREATMENT

What to do if problem occurs?

1. Check the adjustment of brush pressure;
2. Clean the unit and remove dirt stuck around the brushes or under machine;
3. Lubricate the gear parts;
4. Check that the round brushes can turn around easily.

NOTE:

1. This Unit is designed for outdoor hard floor. Home carpet may not suitable.
2. Before Using, make sure the unit is in good and safe condition;
3. Heavy stone and large size tree branch may unable to be collected;
4. When sweeping very fine dust, small trace may remain in the middle of the machine and a second sweeping is suggested to the best result;
5. Please avoid sweeping long rope yarn like material to avoid brushes tangling and damage;

SAFETY WARNING!

1. When sweeping and operating the machine in front of machine and children, please pay much more attention;
2. Please do not take the unit as toys for children;
3. Please do not let your hair, feet, figures, clothes etc. of your body close to the garbage collecting mouth of the unit;
4. Please do not operate the sweeper barefoot or wearing shoes with figure out;
5. Please do not sweeping stuff of heat, burning or smoking to avoid fire hazard and person injury;
6. Please do not collecting flammable and explosive and stuff and poisonous material;
7. When collecting and empty glasses or material of sharp and with hurting dangerous, please wear safety gloves;
8. Please do not operate and store the unit close to heating source;
9. Please store the unit in safety places;