

10-STEP ROLLING STEEL WAREHOUSE LADDER - LAD-10-21-G

APPROX WEIGHT: 257.6136 lbs. DOES NOT INCLUDE WEIGHT OF POWER OR PACKAGING!!!

*** ANY ADDITIONS, DELETIONS, OR OMISSIONS MUST BE CORRECTED ON THIS DRAWING AS THIS DRAWING WILL BE CONSIDERED ALL INCLUSIVE ***

ALL GRAPHICS PROVIDED ARE FOR REFERENCE ONLY. IF CERTAIN DIMENSIONS ARE CRITICAL PLEASE VERIFY THOSE DIMENSIONS WITH YOUR SALESPERSON

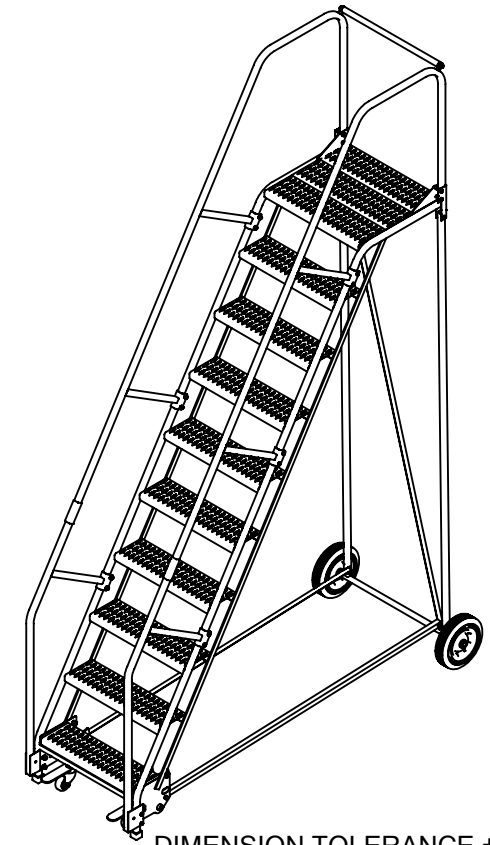
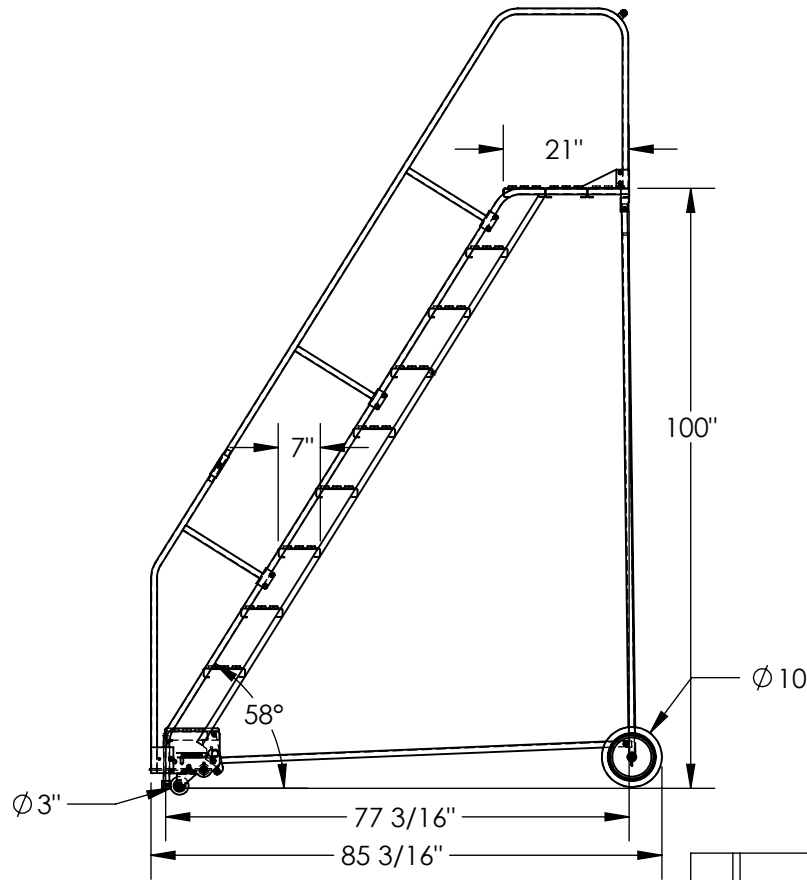
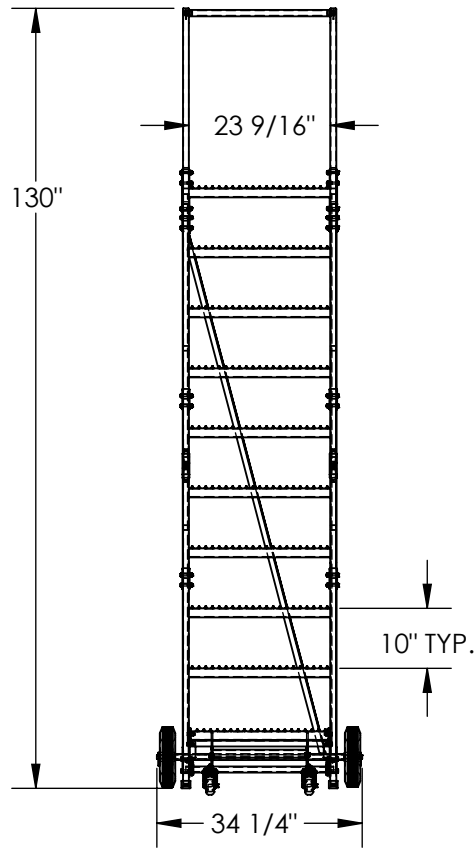

DIMENSION TOLERANCE ± 1/4"

STANDARD FEATURES

- MODEL NUMBER IS LAD-10-21-G
- OVERALL WIDTH IS 34 1/4"
- USABLE WIDTH IS 23 9/16"
- OVERALL LENGTH IS 85 3/16"
- USABLE LENGTH IS 77 3/16"
- OVERALL HEIGHT IS 130"
- TOP STEP HEIGHT IS 100"
- STEP TYPE IS GRIP STRUT
- CLIMB ANGLE IS 58°
- STEP DEPTH IS 7"
- TOP STEP DEPTH IS 21"
- MAX CAPACITY IS 350 LBS
- WHEEL SIZE IS Ø10"
- FRONT WHEEL SIZE IS Ø3"
- TOUGH BAKED IN POWDER COATED BLUE FINISH
- BOTTOM STEP HAS TOUGH BAKED IN POWDER COATED YELLOW FINISH

NOTE

- SOME ASSEMBLY REQUIRED
- TOOL TRAY SOLD SEPARATELY
- SAFETY GATE SOLD SEPARATELY

SPECIAL FEATURES

NONE

APPROVAL

I, THE UNDERSIGNED, AGREE THAT THE PRODUCT AS REPRESENTED SATISFIES DESIGN AND DIMENSION REQUIREMENTS. I ALSO ACKNOWLEDGE MY DUTY TO CONFIRM PRODUCT AND INSTALLATION COMPLIANCE WITH ALL APPLICABLE FEDERAL, STATE AND LOCAL REGULATIONS AND STANDARDS.

UNITS REQUIRING APPROVAL DRAWINGS OR MODIFIED ARE NON-RETURNABLE

[] As drawn [] As marked

Signed: _____ Date: _____

Printed Name: _____

LEAD TIME WILL START UPON RECEIPT OF SIGNED APPROVAL DRAWING

DISTRIBUTOR'S NAME:		P.O.#
VESTIL MANUFACTURING		X
DRAWN BY: BCN		DATE: 7/14/2016
REFERENCE: X		SCALE: 1:32
QUOTED LEAD TIME: X		QUOTE # X
		SALES: X
		FILE NAME: 44-007-130