

TIP-N-ROLL LADDER, NON STRADDLE, FDA COMPLIANT FINISH - LAD-TRN-60-5-FDA

APPROX WEIGHT: 123.41 lbs.
DOES NOT INCLUDE WEIGHT OF POWER OR PACKAGING!!!

*** ANY ADDITIONS, DELETIONS, OR OMISSIONS MUST BE CORRECTED ON THIS DRAWING AS THIS DRAWING WILL BE CONSIDERED ALL INCLUSIVE ***
ALL GRAPHICS PROVIDED ARE FOR REFERENCE ONLY. IF CERTAIN DIMENSIONS ARE CRITICAL PLEASE VERIFY THOSE DIMENSIONS WITH YOUR SALESPERSON

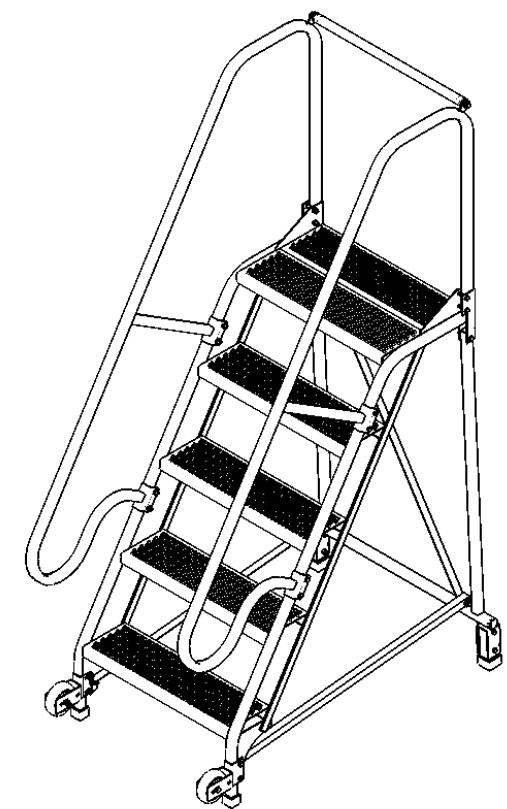
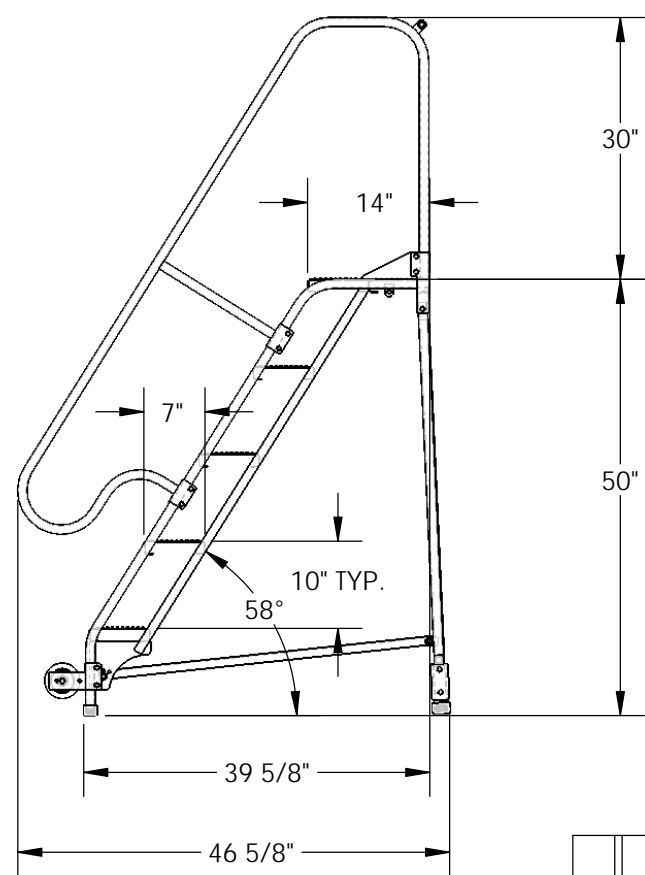
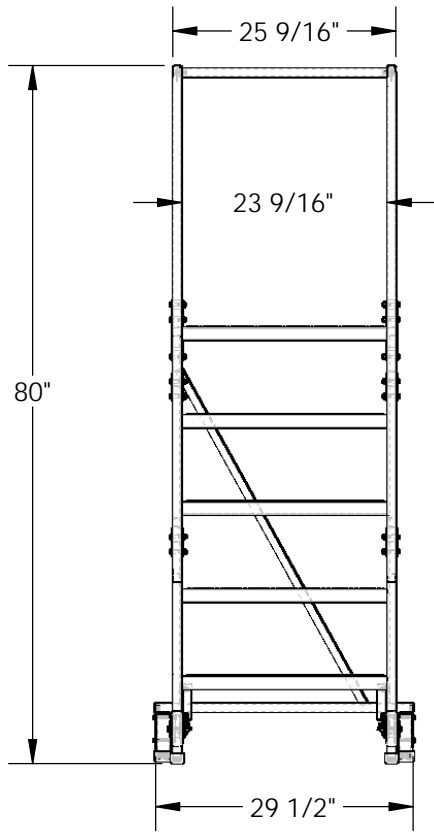

DIMENSION TOLERANCE ± 1/4"

STANDARD FEATURES

- MODEL NUMBER IS LAD-TRN-60-5-FDA
- OVERALL WIDTH IS 29 1/2"
- USABLE WIDTH IS 23 9/16"
- OVERALL LENGTH IS 46 5/8"
- USABLE LENGTH IS 39 5/8"
- OVERALL HEIGHT IS 80"
- PLATFORM HEIGHT IS 50"
- STEP TYPE IS PERFORATED
- CLIMB ANGLE IS 58°
- STEP DIMENSION IS 24" x 7"
- TOP STEP DIMENSION IS 24" x 14"
- MAX CAPACITY IS 350 LBS

SPECIAL FEATURES

- TOUGH BAKED IN POWDER COATED
- FDA COMPLIANT WHITE FINISH

NOTE

- SOME ASSEMBLY REQUIRED
- TOOL TRAY SOLD SEPARATELY

APPROVAL

I, THE UNDERSIGNED, AGREE THAT THE PRODUCT AS REPRESENTED SATISFIES DESIGN AND DIMENSION REQUIREMENTS. I ALSO ACKNOWLEDGE MY DUTY TO CONFIRM PRODUCT AND INSTALLATION COMPLIANCE WITH ALL APPLICABLE FEDERAL, STATE AND LOCAL REGULATIONS AND STANDARDS.

ANY MODIFIED UNITS ARE NON-RETURNABLE

[] As drawn [] As marked

Signed: _____ Date: _____

Printed Name: _____

LEAD TIME WILL START UPON RECEIPT OF SIGNED APPROVAL DRAWING

FOR INTERNAL USE ONLY PROJECT SIGN OFF	
SALES	
ENG.	
FAB.	
POWER	

DISTRIBUTOR'S NAME:		P.O.#
VESTIL MANUFACTURING		X
DRAWN BY: BCN		W.O.#
DATE: 8/10/2016		X
REFERENCE: X	SCALE: 1:22	SALES: X
QUOTED LEAD TIME: X	QUOTE #	FILE NAME:
	X	44-007-411