

TIP-N-ROLL MOBILE LADDER, STRADDLE - LAD-TRS-50-6-P

APPROX WEIGHT: 155.77 lbs.
DOES NOT INCLUDE WEIGHT OF POWER OR PACKAGING!!!

*** ANY ADDITIONS, DELETIONS, OR OMISSIONS MUST BE CORRECTED ON THIS DRAWING AS THIS DRAWING WILL BE CONSIDERED ALL INCLUSIVE ***
ALL GRAPHICS PROVIDED ARE FOR REFERENCE ONLY. IF CERTAIN DIMENSIONS ARE CRITICAL PLEASE VERIFY THOSE DIMENSIONS WITH YOUR SALESPERSON

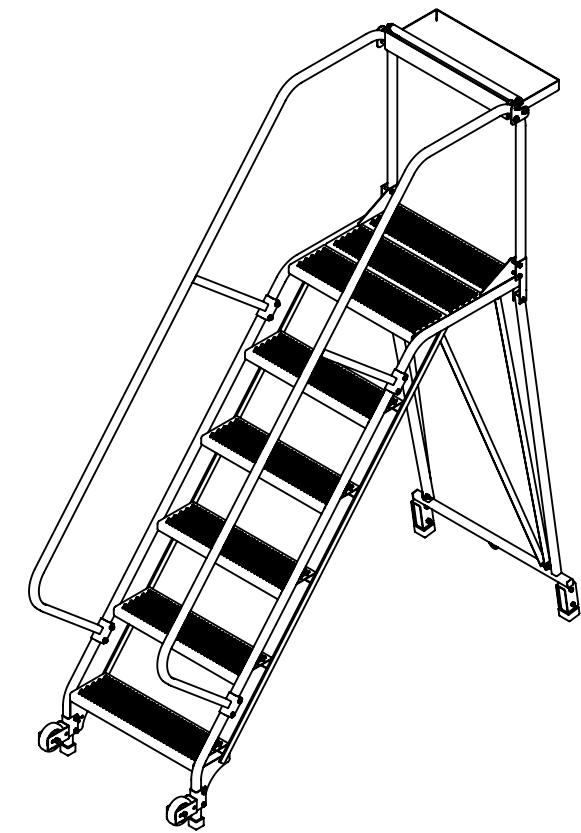
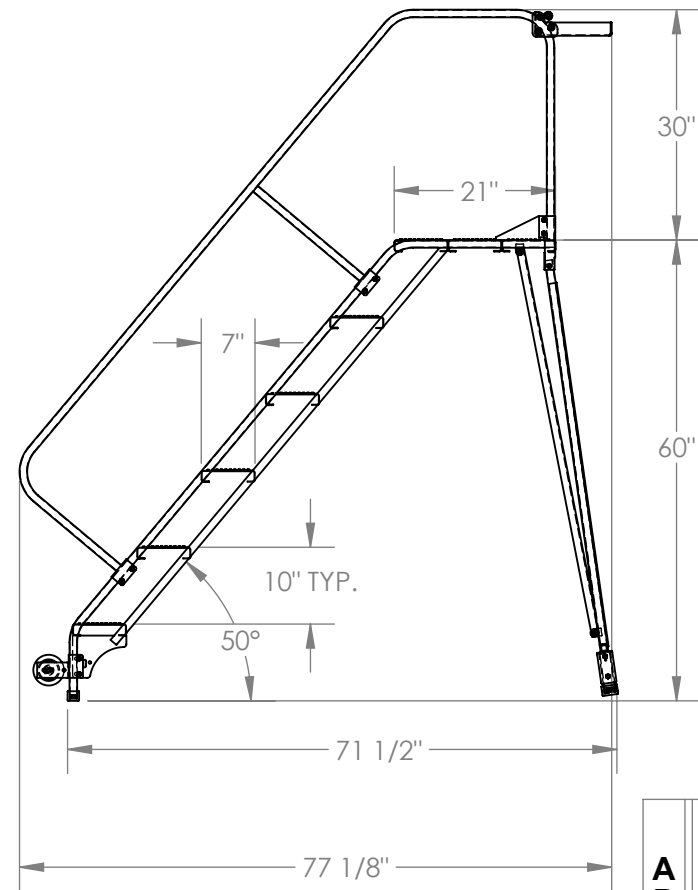
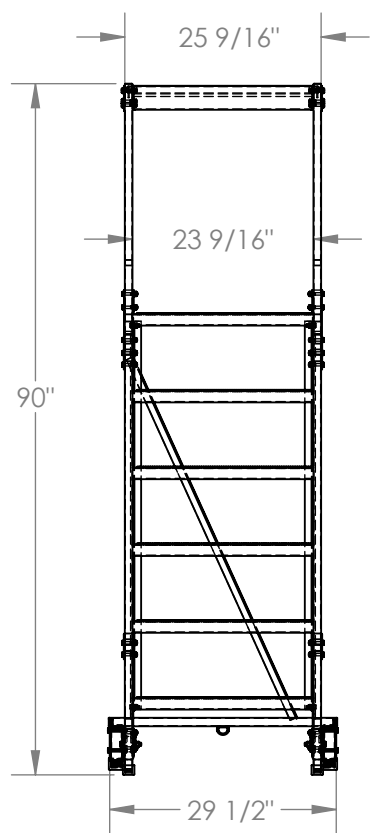

DIMENSION TOLERANCE ± 1/4"

STANDARD FEATURES

- MODEL NUMBER IS LAD-TRS-50-6-P
- OVERALL WIDTH IS 29 1/2"
- USABLE WIDTH IS 23 9/16"
- OVERALL LENGTH
- W/ TOOL TRAY IS 77 1/8"
- USABLE LENGTH IS 71 1/2"
- OVERALL HEIGHT IS 90"
- PLATFORM HEIGHT IS 60"
- COLOR IS VESTIL BLUE
- STEP TYPE IS PERFORATED
- CLIMB ANGLE IS 50°
- STEP DIMENSION IS 24" x 7"
- TOP STEP DIMENSION IS 24" x 21"
- MAX CAPACITY IS 350 LBS

SPECIAL FEATURES

NONE
NOTE
SOME ASSEMBLY REQUIRED

APPROVAL

I, THE UNDERSIGNED, AGREE THAT THE PRODUCT AS REPRESENTED SATISFIES DESIGN AND DIMENSION REQUIREMENTS. I ALSO ACKNOWLEDGE MY DUTY TO CONFIRM PRODUCT AND INSTALLATION COMPLIANCE WITH ALL APPLICABLE FEDERAL, STATE AND LOCAL REGULATIONS AND STANDARDS.
ALL SPECIAL UNITS ARE NON-RETURNABLE
[] As drawn [] As marked

Signed: _____ Date: _____

LEAD TIME WILL START UPON RECEIPT OF SIGNED APPROVAL DRAWING

FOR INTERNAL USE ONLY PROJECT SIGN OFF	
SALES	
ENG.	
FAB.	
POWER	

DISTRIBUTOR'S NAME:		P.O.#
VESTIL MANUFACTURING		X
DRAWN BY:	DATE:	W.O.#
B.NOETHNAGEL	8/26/2015	X
REFERENCE:	SCALE:	SALES:
X	1:25	X
QUOTED LEAD TIME:	QUOTE #	FILE NAME:
X	X	44-007-350