

ALUMA-LITE® DAVIT CRANE NEW!

Individually tested and certified at 125% W.L.L

OZA500DAV, OZA1000DAV



Options for faster lowering and raising

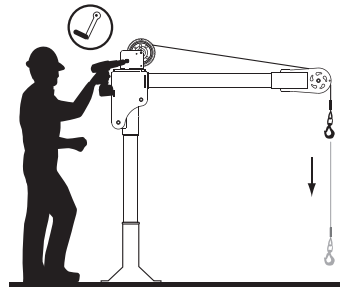

Manual winch w/drill drive adaptor

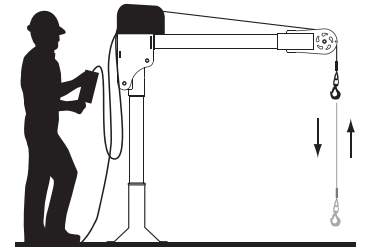

AC and DC power winches available
See page 25

Ultra
lightweight
& portable

500 lbs. and 1,000 lbs. Capacity

Features

- Lightweight aerospace grade aluminum construction
- 360 degree rotation
- 3 different boom height adjustments
- Durable powder coat finish
- Truly Portable Design
- One-Person Assembly (No Tools Needed)
- Manual Din rated CE winch with brake (Includes power drill adaptor)
- AC & DC winch options

Weight

Weight (excluding winch)	Boom	Mast	Net
OZA500DAV (lbs)	12	12	24
OZA1000DAV (lbs)	25	22	47

WIRE/SYNTHETIC ROPE ASSEMBLIES
(sold separately) Custom length available.

Manual winch: 3/16" - 80 ft max. lift length • 1/4" - 55ft max. lift length
AC/DC Electric Winch: 3/16" - 90 ft max. lift length • 1/4" - 45ft max. lift length

OZA1000DAV shown with optional
OZPED1-TP Pedestal base and
OZGAL.25-55B wire rope assembly
and OZHB10 headache ball
Bases, cable assemblies and headache ball sold separately

OZA500DAV DIMENSIONS

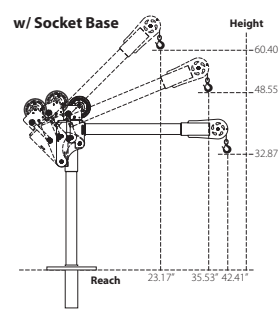
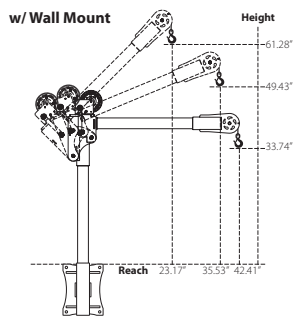
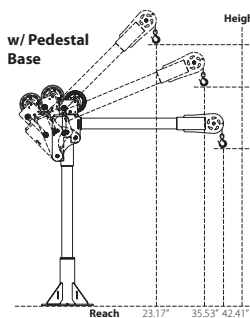

OZA500DAV Load Ratings (lbs.)

Based on 3/16" wire rope

	1st. Layer	Mid. Drum	Full Drum
Position 1 (0°)	275	275	275
Position 2 (+22.5°)	330	330	330
Position 3 (+45°)	500	500	500

OZA500DAV BASES (sold separately) Comes with mounting template.

OZPED3

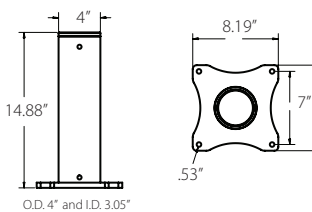

OZSOC3

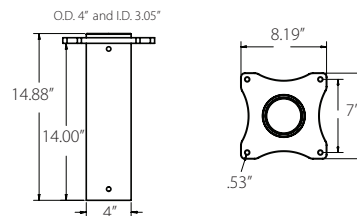

OZWALL3

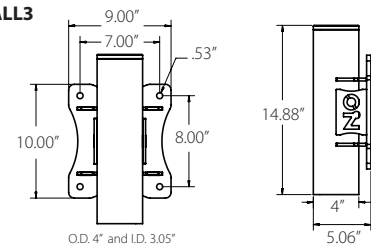

Dimensions and illustrations are for reference only and subject to change without notice.

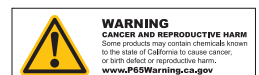

OZA1000DAV DIMENSIONS

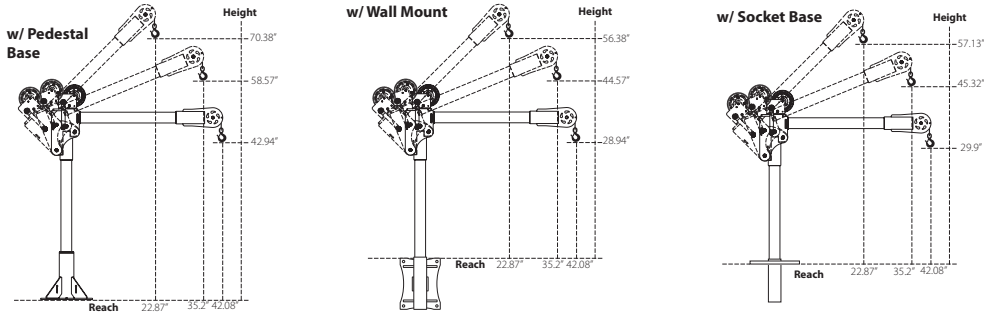

OZA1000DAV Load Ratings (lbs.)

Based on 1/4" wire or 3/16" Ultrtex synthetic rope

	1st. Layer	Mid. Drum	Full Drum
Position 1 (0°)	550	550	550
Position 2 (+22.5°)	650	650	550
Position 3 (+45°)	1000	875	550

OZA1000DAV BASES (sold separately) Comes with mounting template.

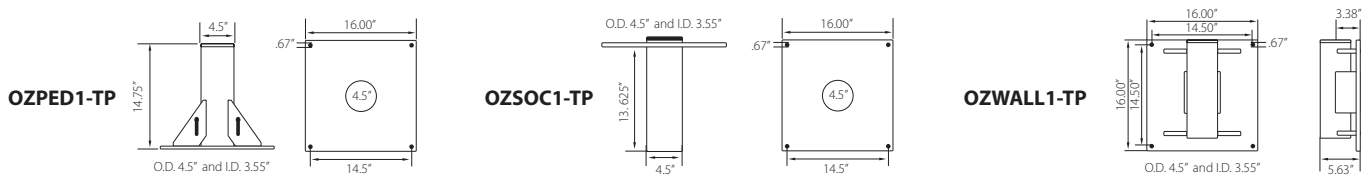

Dimensions and illustrations are for reference only and subject to change without notice.

COMING SOON

XR SERIES DAVIT CRANE

500lbs. and 1000 lbs. Capacity

- Maximum 62-inch reach and 87-inch hook height (both models)
- Maintains maximum weight capacity in all positions
- 4 different boom height adjustments
- Durable steel construction with powder coat finish
- Manual & Electric winch options



PORTABLE DAVIT BASE

For all OZ Lifting davit cranes up to 1200 lbs capacity

- Optional floor anchoring system allows the davit to rotate while under load (when base is not anchored the davit must remain in a forward position when lifting)
- Oversized casters make rolling the base and moving loads easy
- Compatible with all OZ lifting davit cranes up to 1200 lbs capacity
- Durable steel construction with powder coat finish
- Davit crane sold separately
- Patent pending



WIRE/SYNTHETIC ROPE ASSEMBLIES

Steel Wire Rope (For manual winch)

OZGAL.19-80B	3/16" x 80'	Galvanized cable assembly
OZSS.19-80B	3/16" x 80'	Stainless steel cable assembly
OZGAL.25-55B	1/4" x 55'	Galvanized cable assembly
OZSS.25-55B	1/4" x 55'	Stainless steel cable assembly

Above cable assemblies come with swaged ball and swivel hook with latch.

Custom cable length available.

3/16" - 80 ft max. length • 1/4" - 55ft max. length

Steel Wire Rope (For manual and power winch)

OZGAL.19-90	3/16" x 90'	Galvanized cable assembly
OZSS.19-90	3/16" x 90'	Stainless Steel cable assembly
OZGAL.25-45	1/4" x 45'	Galvanized cable assembly
OZSS.25-45	1/4" x 45'	Stainless Steel cable assembly

All cable assemblies come with a swivel hook with latch.

Custom cable length available.

3/16" - 90 ft max. length • 1/4" - 45ft max. length

Synthetic Rope

OZSR.19-15	3/16" x 15'	Ultrax Synthetic Rope
OZSR.19-50	3/16" x 50'	Ultrax Synthetic Rope
OZSR.19-90	3/16" x 90'	Ultrax Synthetic Rope
OZSR.25-50	1/4" x 50'	Ultrax Synthetic Rope
OZSR.25-75	1/4" x 75'	Ultrax Synthetic Rope
OZSR.31-55	5/16" x 55'	Ultrax Synthetic Rope
OZSR.38-45	3/8" x 45'	Ultrax Synthetic Rope

All synthetic rope assemblies come with looped ends and pre-installed swivel hook with latch



ROLLER BAG

OZRB1

Provides an easy way to transport and store your davit crane. Compatible with Steel 500 & 1000lb, Aluma-Lite 500 & 1000lb, CompOZite 1200 lb, CompOZite Elite 1200lb and Tele-Pro 500 & 1200lb davit cranes. Roller bag is sold separately from davit cranes.



HEADACHE BALL

OZHB10

Keeps your wire rope tensioned even when lowering the hook with no load. Compatible with 3/16" and 1/4" wire rope assemblies. Headache balls sold separately from all davit cranes and wire rope assemblies.

