

MECHANICAL DOCKLEVELER - RR-78-40

APPROX WEIGHT: 2526 lbs.
 DOES NOT INCLUDE WEIGHT OF POWER OR PACKAGING!!!

*** ANY ADDITIONS, DELETIONS, OR OMISSIONS MUST BE CORRECTED ON THIS DRAWING AS THIS DRAWING WILL BE CONSIDERED ALL INCLUSIVE ***

ALL GRAPHICS PROVIDED ARE FOR REFERENCE ONLY. IF CERTAIN DIMENSIONS ARE CRITICAL PLEASE VERIFY THOSE DIMENSIONS WITH YOUR SALESPERSON

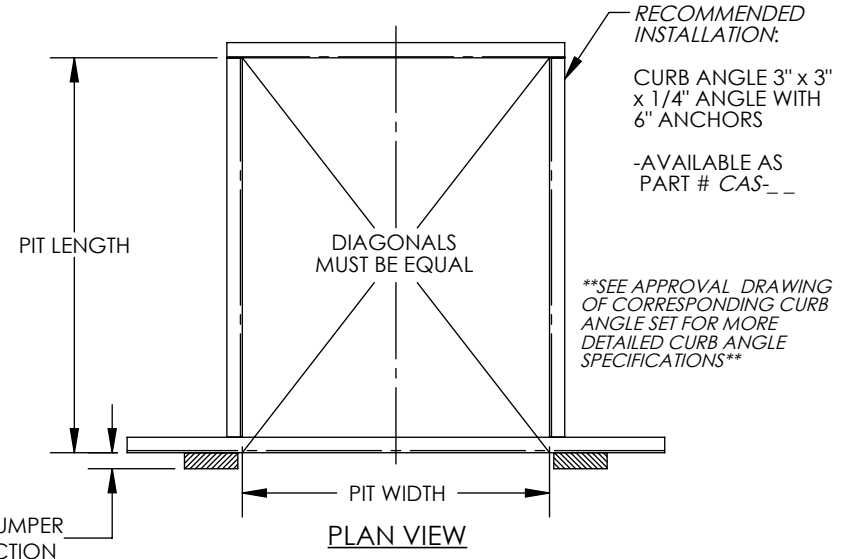
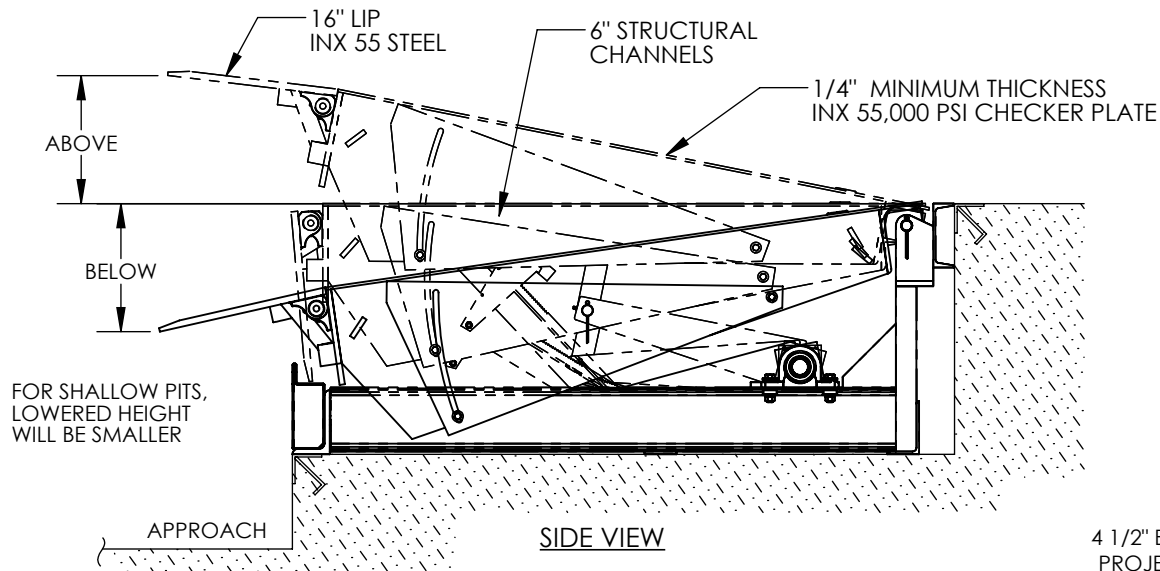

FOR INTERNAL USE ONLY
PROJECT SIGN OFF

SALES	
ENG.	
FAB.	
POWER	

ARCHITECTURAL REVIEW FOR CORRECTNESS OF PIT AND FOR COMPLIANCE TO STATE AND LOCAL CODES IS RECOMMENDED.

PLEASE CIRCLE SPECIFICATIONS:

NEW	(PIT) CONSTRUCTION
EXISTING	(PIT) CONSTRUCTION

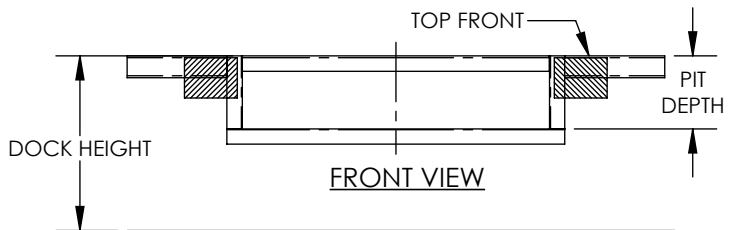

SEE DRAWING NUMBERS RR-1 THRU RR-4 FOR MORE INSTALLATION INFO

STANDARD FEATURES

- DOCKLEVELER MODEL NUMBER: RR-78-40
- PIT WIDTH IS: 86 INCHES
- PIT LENGTH IS: 86 INCHES
- PIT DEPTH IS 24 INCHES AT FRONT, 23 3/4 INCHES AT BACK
- DOCK HEIGHT IS 48 INCHES (48 INCHES STANDARD)
- DOCKLEVELER CAPACITY (GROSS ROLLING LOAD) IS 40,000 LBS.
- VERTICAL SERVICE RANGE IS 12 INCHES ABOVE AND 12 INCHES BELOW DOCK
- INCLUDES (2) 1014-4.5 LAMINATED DOCK BUMPERS
- DURABLE LIQUID PAINT BROWN FINISH WITH YELLOW DECK SIDES & TOE GUARDS
- ***SINGLE AXLE CAPACITY NOT TO EXCEED 70% OF LOAD***

ALL STRUCTURAL STEEL CONSTRUCTION WELDING MEETS AWS.
 DESIGN, ENGINEERING, AND FABRICATION COMPLIES WITH OSHA & ANSI MH30.1
 -INSTALL TO MEET ALL APPLICABLE STATE & LOCAL CODES FOR YOUR AREA!

SPECIAL FEATURES

NONE

APPROVAL

I, THE UNDERSIGNED, AGREE THAT THE PRODUCT AS REPRESENTED SATISFIES DESIGN AND DIMENSION REQUIREMENTS. I ALSO ACKNOWLEDGE MY DUTY TO CONFIRM PRODUCT AND INSTALLATION COMPLIANCE WITH ALL APPLICABLE FEDERAL, STATE AND LOCAL REGULATIONS AND STANDARDS.

ANY MODIFIED UNITS ARE NON-RETURNABLE

[] As drawn [] As marked

Signed: _____ Date: _____

Printed Name: _____

LEAD TIME WILL START UPON RECEIPT OF SIGNED APPROVAL DRAWING

DISTRIBUTOR'S NAME:		P.O.#
VESTIL MANUFACTURING		X
DRAWN BY: TJM		W.O.#
DATE: 02/27/12		X
REFERENCE: X	SCALE: NTS	SALES: X
QUOTED LEAD TIME: X	QUOTE #	FILE NAME:
	X	07-007-059