

SAFETY SWING GATE - SSG-3-BK

APPROX WEIGHT: 37.02 lbs.
 DOES NOT INCLUDE WEIGHT OF POWER OR PACKAGING!!!

*** ANY ADDITIONS, DELETIONS, OR OMISSIONS MUST BE CORRECTED ON THIS DRAWING AS THIS DRAWING WILL BE CONSIDERED ALL INCLUSIVE ***

ALL GRAPHICS PROVIDED ARE FOR REFERENCE ONLY. IF CERTAIN DIMENSIONS ARE CRITICAL PLEASE VERIFY THOSE DIMENSIONS WITH YOUR SALESPERSON

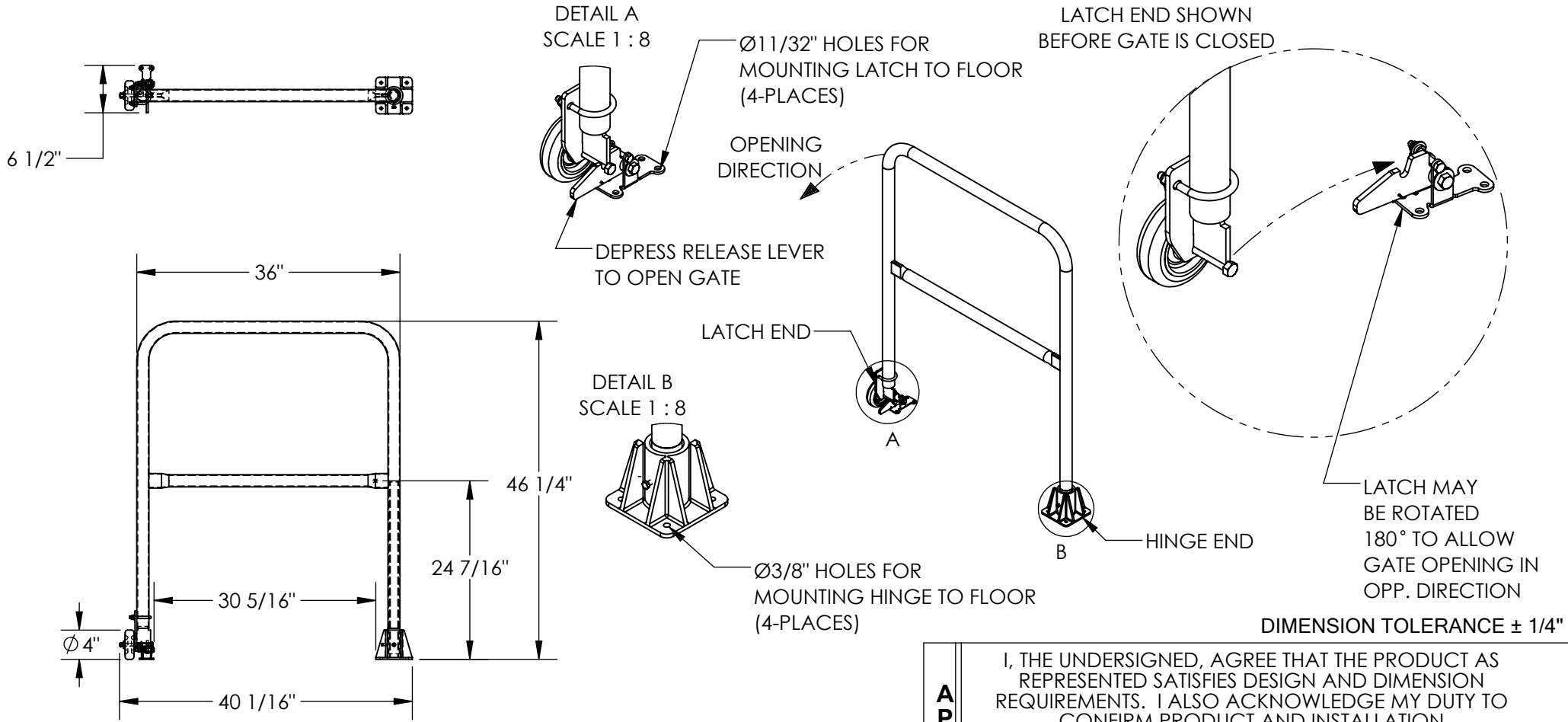

GATE OPENS IN JUST ONE DIRECTION. LATCH CAN BE POSITIONED TO ALLOW OPENING EITHER WAY. HINGE END CAN BE LOCATED ON RIGHT OR LEFT SIDE.

STANDARD FEATURES

- MODEL NUMBER: SSG-3-BK
- OVERALL WIDTH: 6 1/2"
- OVERALL LENGTH: 40 1/16"
- INSIDE OPENING LENGTH: 30 5/16"
- GATE LENGTH: 36"
- OVERALL HEIGHT: 46 1/4"
- WELDED STEEL CONSTRUCTION
- TOUGH BAKED IN POWDER COATED BLACK FINISH

SPECIAL FEATURES

NONE

APPROVAL

I, THE UNDERSIGNED, AGREE THAT THE PRODUCT AS REPRESENTED SATISFIES DESIGN AND DIMENSION REQUIREMENTS. I ALSO ACKNOWLEDGE MY DUTY TO CONFIRM PRODUCT AND INSTALLATION COMPLIANCE WITH ALL APPLICABLE FEDERAL, STATE AND LOCAL REGULATIONS AND STANDARDS.

UNITS REQUIRING APPROVAL DRAWINGS OR MODIFIED ARE NON-RETURNABLE

[] As drawn [] As marked

Signed: _____ Date: _____

Printed Name: _____

LEAD TIME WILL START UPON RECEIPT OF SIGNED APPROVAL DRAWING

DISTRIBUTOR'S NAME:		P.O.#
VESTIL MANUFACTURING		X
DRAWN BY: JGP		W.O.#
DATE: 5/6/2021		X
REFERENCE: X	SCALE: 1:20	SALES: X
QUOTED LEAD TIME: X	QUOTE #	FILE NAME:
	X	23-007-823-001