

STEEL WHEEL RISER - SWR-24-6-84

APPROX WEIGHT: 281.99 lbs.
DOES NOT INCLUDE WEIGHT OF POWER OR PACKAGING!!!

ANY ADDITIONS, DELETIONS, OR OMISSIONS MUST BE CORRECTED ON THIS DRAWING AS THIS DRAWING WILL BE CONSIDERED ALL INCLUSIVE

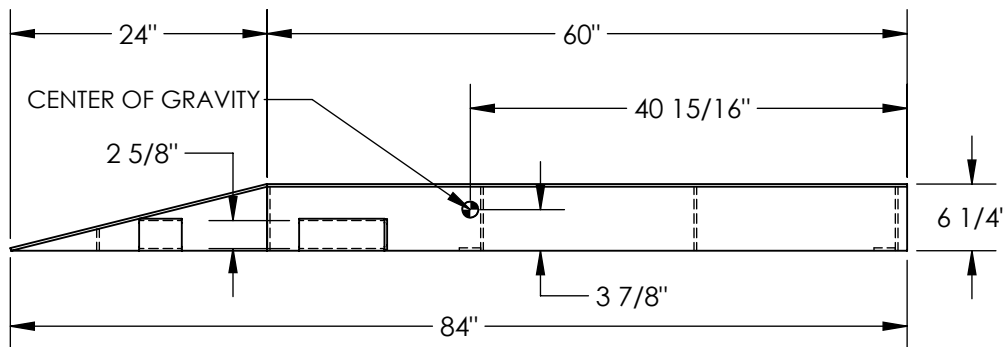
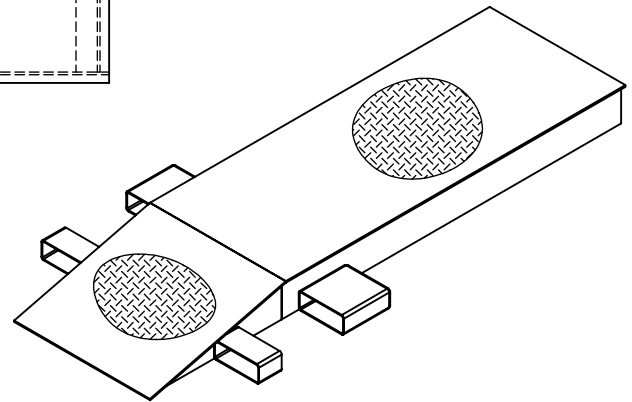
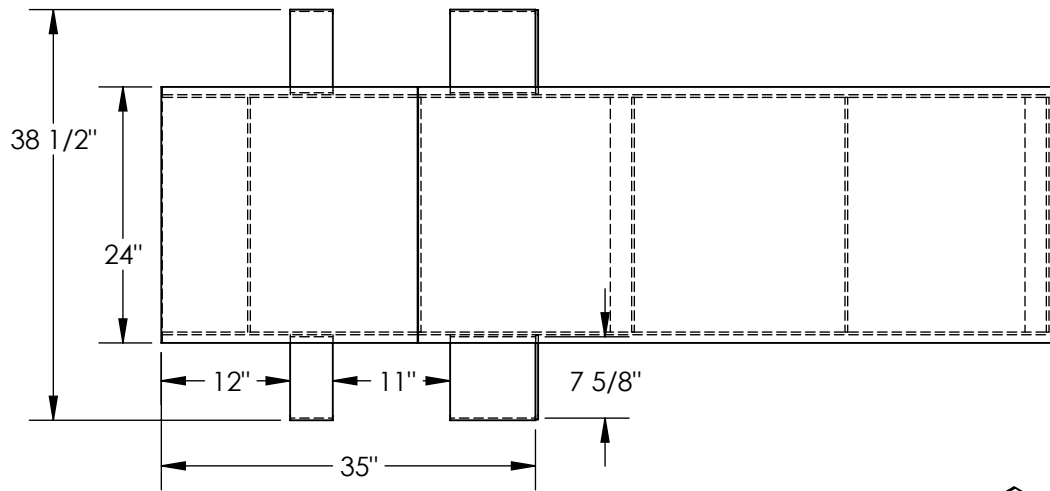

FOR INTERNAL USE ONLY PROJECT SIGN OFF	
SALES	
ENG.	
FAB.	
POWER	

ALL GRAPHICS PROVIDED ARE FOR REFERENCE ONLY. IF CERTAIN DIMENSIONS ARE CRITICAL PLEASE VERIFY THOSE DIMENSIONS WITH YOUR SALESPERSON

DIMENSION TOLERANCE $\pm 1/4"$

STANDARD FEATURES

- MODEL NUMBER IS: SWR-24-6-84
- UNIFORM CAPACITY PER PAIR IS: 40,000 LBS
- OVERALL WIDTH IS: 38 1/2"
- USABLE WIDTH IS: 24"
- OVERALL LENGTH IS: 84"
- LEVEL LENGTH IS: 60"
- OVERALL HEIGHT IS: 6 1/4"
- TREADPLATE RAMP CONSTRUCTION
- USABLE FORK POCKET SIZE (W x H): 7 5/8" x 2 5/8"
- DURABLE LIQUID PAINT BROWN FINISH

SPECIAL FEATURES

NONE

APPROVAL

I, THE UNDERSIGNED, AGREE THAT THE PRODUCT AS REPRESENTED SATISFIES DESIGN AND DIMENSION REQUIREMENTS. I ALSO ACKNOWLEDGE MY DUTY TO CONFIRM PRODUCT AND INSTALLATION COMPLIANCE WITH ALL APPLICABLE FEDERAL, STATE AND LOCAL REGULATIONS AND STANDARDS.

ANY MODIFIED UNITS ARE NON-RETURNABLE

As drawn As marked

Signed: _____ Date: _____

Printed Name: _____

LEAD TIME WILL START UPON RECEIPT OF SIGNED APPROVAL DRAWING

DISTRIBUTOR'S NAME:		P.O.#
VESTIL MANUFACTURING		X
DRAWN BY: ALH		W.O.#
DATE: 6/16/2011		X
REFERENCE: X	SCALE: 1:18	SALES: X
QUOTED LEAD TIME: X	QUOTE # X	FILE NAME:
		18-007-085