

CENTRAL PICK UP LOOP FOR STEEL WHEEL RISERS: SWR-CPL-24-8-72

APPROX WEIGHT: 660.63 lbs.
DOES NOT INCLUDE WEIGHT OF POWER OR PACKAGING!!!

*** ANY ADDITIONS, DELETIONS, OR OMISSIONS MUST BE CORRECTED ON THIS DRAWING AS THIS DRAWING WILL BE CONSIDERED ALL INCLUSIVE ***
ALL GRAPHICS PROVIDED ARE FOR REFERENCE ONLY. IF CERTAIN DIMENSIONS ARE CRITICAL PLEASE VERIFY THOSE DIMENSIONS WITH YOUR SALESPERSON

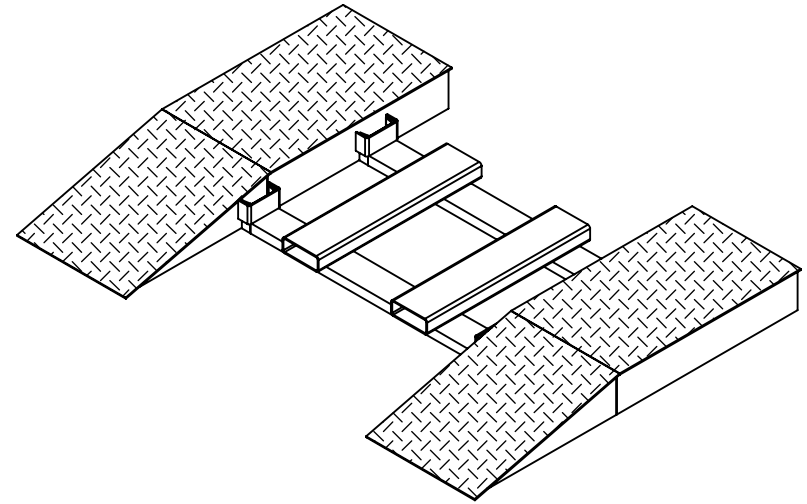
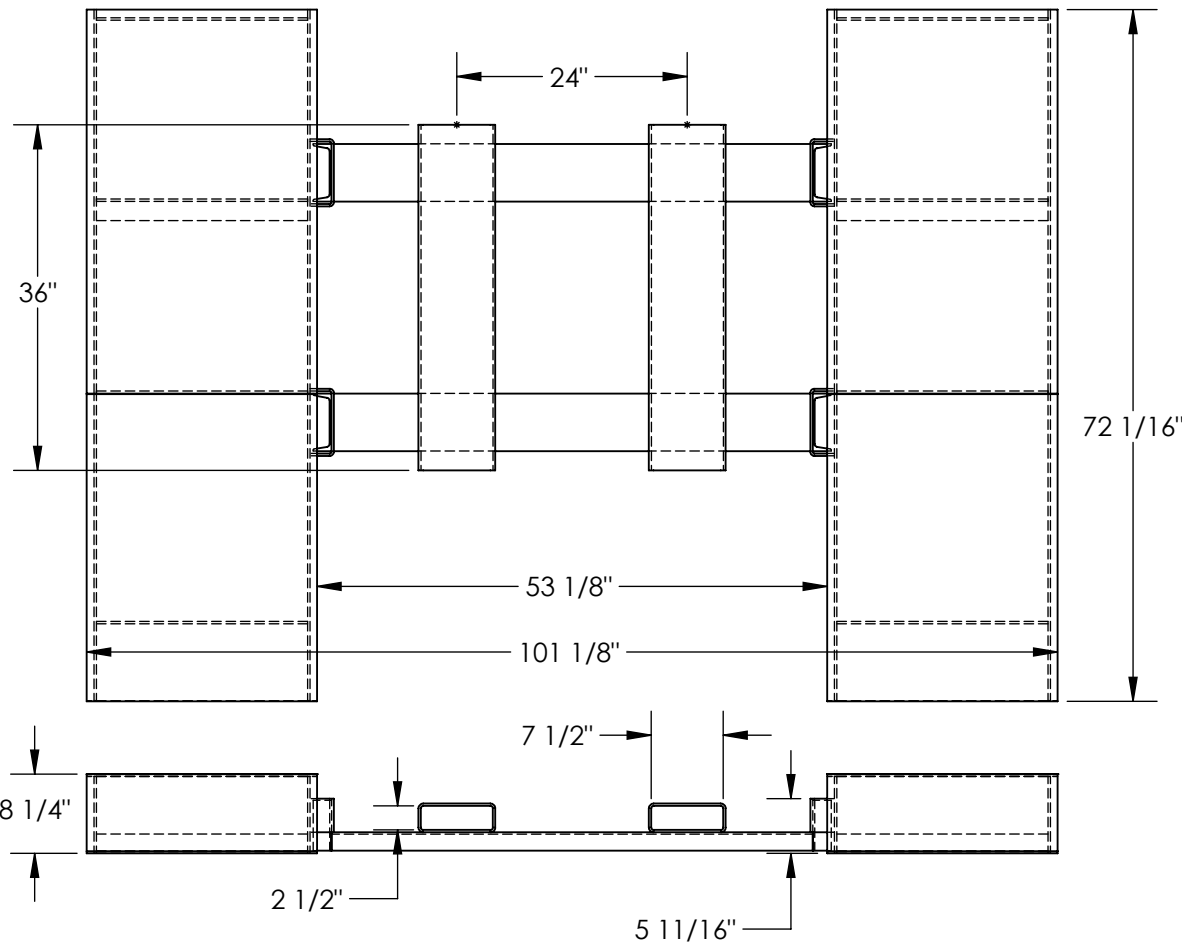

DIMENSION TOLERANCE $\pm 1/4"$

APPROVAL	I, THE UNDERSIGNED, AGREE THAT THE PRODUCT AS REPRESENTED SATISFIES DESIGN AND DIMENSION REQUIREMENTS. I ALSO ACKNOWLEDGE MY DUTY TO CONFIRM PRODUCT AND INSTALLATION COMPLIANCE WITH ALL APPLICABLE FEDERAL, STATE AND LOCAL REGULATIONS AND STANDARDS.	
	UNITS REQUIRING APPROVAL DRAWINGS OR MODIFIED ARE NON-RETURNABLE	
	[] As drawn [] As marked	
	Signed: _____	Date: _____
	Printed Name: _____	
LEAD TIME WILL START UPON RECEIPT OF SIGNED APPROVAL DRAWING		

STANDARD FEATURES

- MODEL NUMBER IS SWR-CPL-24-8-72
- OVERALL WIDTH IS 101 1/8"
- WIDTH BETWEEN RISERS WHEN INSTALLED: 53 1/8"
- OVERALL HEIGHT: 8 1/4"
- HEIGHT FROM GROUND TO TOP OF SIDE LOOPS WHEN INSTALLED: 5 11/16"
- OVERALL DEPTH: 72 1/16"
- 7 1/2"W x 2 1/2"H USABLE FORK POCKETS ON 24" CENTERS
- FORK ATTACHMENT INSERTS INTO LOOPS WELDED TO INNER SIDES OF WHEEL RISERS
- STEEL CONSTRUCTION
- DURABLE LIQUID PAINT BROWN FINISH

SPECIAL FEATURES

NONE

DISTRIBUTOR'S NAME:		P.O.#
VESTIL MANUFACTURING		X
DRAWN BY: T.HARKRADER		W.O.#
DATE: 4/14/2023		X
REFERENCE: X	SCALE: 1:20	SALES: X
QUOTED LEAD TIME: X	QUOTE #	FILE NAME:
	X	18-007-415