

ALUMINUM TRUCK DOCKBOARD WITH STEEL SAFETY CURB - TAS-20-7236

APPROX WEIGHT: 137.26 lbs.
 DOES NOT INCLUDE WEIGHT OF POWER OR PACKAGING!!!

*** ANY ADDITIONS, DELETIONS, OR OMISSIONS MUST BE CORRECTED ON THIS DRAWING AS THIS DRAWING WILL BE CONSIDERED ALL INCLUSIVE ***
 ALL GRAPHICS PROVIDED ARE FOR REFERENCE ONLY. IF CERTAIN DIMENSIONS ARE CRITICAL PLEASE VERIFY THOSE DIMENSIONS WITH YOUR SALESPERSON

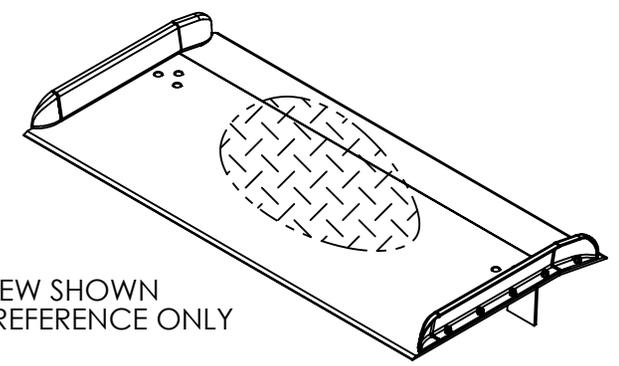
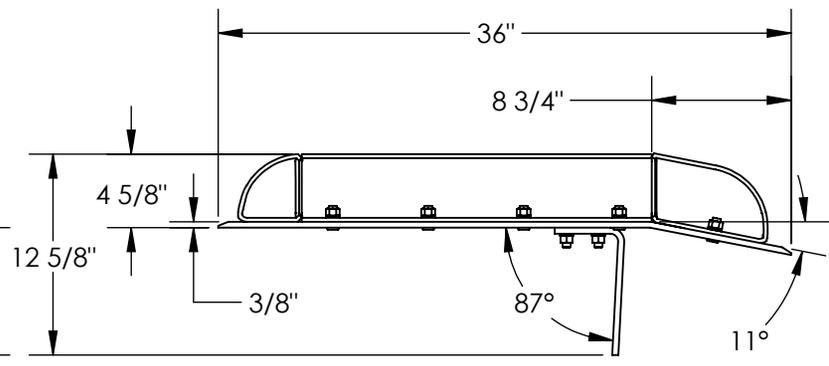
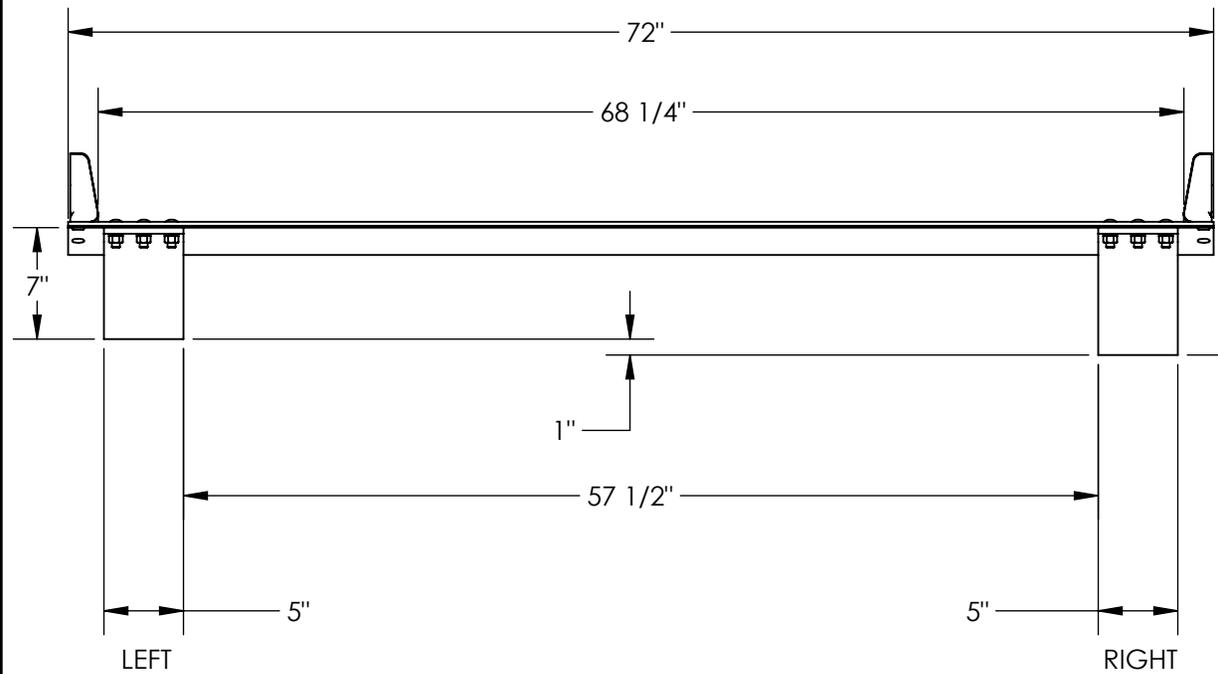

3D VIEW SHOWN FOR REFERENCE ONLY

LEGS: RIGHT LEG IS 8" LG, LEFT LEG IS 7" LG. LEGS ARE UNEVEN TO CREATE A GAP SO DOCKBOARD CAN BE PICKED UP BY A FORK LIFT

STANDARD FEATURES

- MODEL NUMBER IS: TAS-20-7236
- MAX CAPACITY IS: 20,000 LBS
- OVERALL WIDTH IS: 72"
- USABLE WIDTH IS: 68 1/4"
- OVERALL LENGTH IS: 36"
- USABLE LENGTH IS: 36"
- OVERALL HEIGHT IS: 12 5/8"
- DOCKPLATE THICKNESS: 3/8"
- CROWN IS 11° & 8 3/4" FROM EDGE
- HEIGHT DIFFERENCE IS: 5"
- ALUMINUM CONSTRUCTION WITH BOLT-ON STEEL CURBS

SPECIAL FEATURES

NONE

DIMENSION TOLERANCE ± 1/4"

APPROVAL	I, THE UNDERSIGNED, AGREE THAT THE PRODUCT AS REPRESENTED SATISFIES DESIGN AND DIMENSION REQUIREMENTS. I ALSO ACKNOWLEDGE MY DUTY TO CONFIRM PRODUCT AND INSTALLATION COMPLIANCE WITH ALL APPLICABLE FEDERAL, STATE AND LOCAL REGULATIONS AND STANDARDS.	
	UNITS REQUIRING APPROVAL DRAWINGS OR MODIFIED ARE NON-RETURNABLE	
	[] As drawn [] As marked	
	Signed: _____	Date: _____
	Printed Name: _____	
<i>LEAD TIME WILL START UPON RECEIPT OF SIGNED APPROVAL DRAWING</i>		

DISTRIBUTOR'S NAME:		P.O.#
VESTIL MANUFACTURING		X
DRAWN BY: MTS		W.O.#
DATE: 09/11/2014		X
REFERENCE: X	SCALE: 1:12	SALES: X
QUOTED LEAD TIME: X	QUOTE #	FILE NAME:
	X	11-007-050