

# STEEL TRUCK DOCKBOARD - TS-20-7248

APPROX WEIGHT: 542.49 lbs.  
DOES NOT INCLUDE WEIGHT OF POWER OR PACKAGING!!!

\*\*\* ANY ADDITIONS, DELETIONS, OR OMISSIONS MUST BE CORRECTED ON THIS DRAWING AS THIS DRAWING WILL BE CONSIDERED ALL INCLUSIVE \*\*\*

ALL GRAPHICS PROVIDED ARE FOR REFERENCE ONLY. IF CERTAIN DIMENSIONS ARE CRITICAL PLEASE VERIFY THOSE DIMENSIONS WITH YOUR SALESPERSON

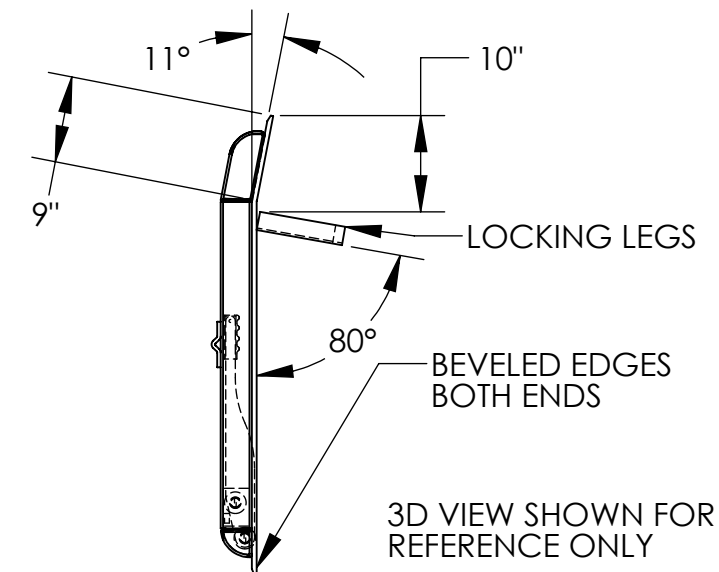
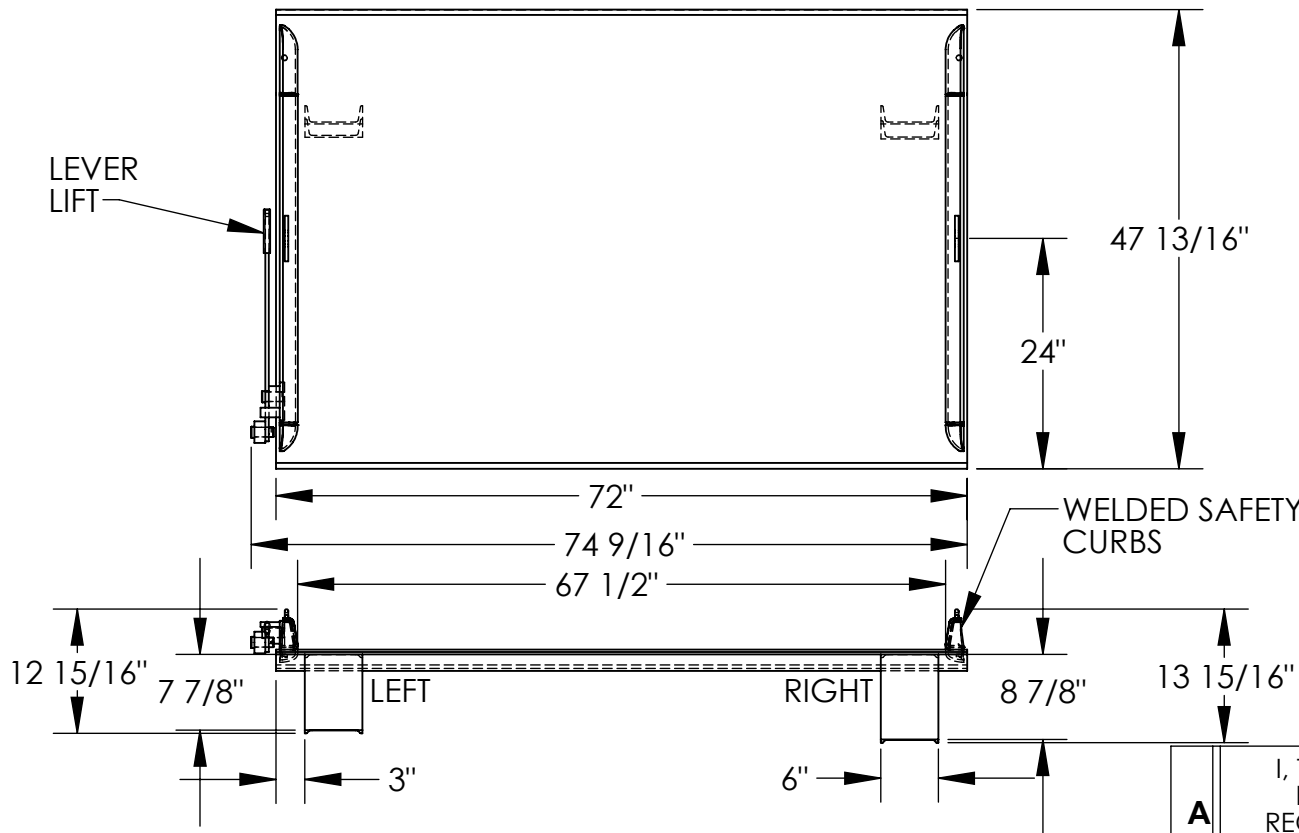

DIMENSION TOLERANCE ± 1/4"

## STANDARD FEATURES

- MODEL NUMBER: TS-20-7248
- CAPACITY: 20,000 LBS
- OVERALL WIDTH: 74 9/16"
- OVERALL LENGTH: 47 13/16"
- DOCKPLATE THICKNESS: 1/2"
- LEVER LIFT IS STANDARD
- LOCKING LEGS ARE 6" WIDE
- RIGHT LEG LENGTH IS 8 7/8"
- LEFT LEG LENGTH IS 7 7/8"
- CROWN IS 11° & 9" FROM EDGE
- HEIGHT DIFFERENCE: 7"
- DURABLE LIQUID PAINT BLUE FINISH

## SPECIAL FEATURES

NONE

APPROVAL

I, THE UNDERSIGNED, AGREE THAT THE PRODUCT AS REPRESENTED SATISFIES DESIGN AND DIMENSION REQUIREMENTS. I ALSO ACKNOWLEDGE MY DUTY TO CONFIRM PRODUCT AND INSTALLATION COMPLIANCE WITH ALL APPLICABLE FEDERAL, STATE AND LOCAL REGULATIONS AND STANDARDS.

**UNITS REQUIRING APPROVAL DRAWINGS OR MODIFIED ARE NON-RETURNABLE**

[ ] As drawn [ ] As marked

Signed: \_\_\_\_\_ Date: \_\_\_\_\_

Printed Name: \_\_\_\_\_

LEAD TIME WILL START UPON RECEIPT OF SIGNED APPROVAL DRAWING

DISTRIBUTOR'S NAME:		P.O.#
VESTIL MANUFACTURING		X
DRAWN BY: ADL	DATE: 12/21/2005	W.O.#
REFERENCE: X	SCALE: 1:20	X
QUOTED LEAD TIME: X	QUOTE #	SALES: X
	X	FILE NAME:
		10-007-086