

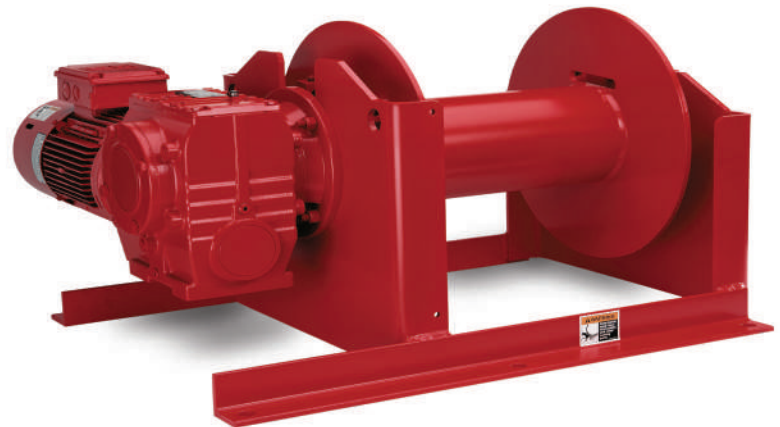

Read this Owner's Manual thoroughly before operating the equipment. Keep it with the equipment at all times. Replacements are available from Thern, Inc., PO Box 347, Winona, MN 55987, 507-454-2996. www.thern.com

IMPORTANT: Please record product information on page 2. This information is required when calling the factory for service.

ORIGINAL TEXT

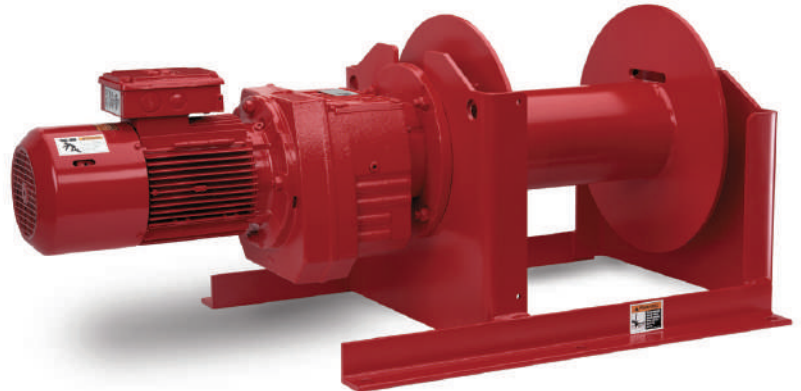

Owner's Manual

For
4HPF/4HWF/4HBN/4HBP Series
Helical/Parallel, Helical/Worm,
Helical/Bevel and Planetary Gear
Power Winches

Two-Year Limited Warranty

Please record the following:

Date Purchased: _____

Model No.: _____

Serial No.: _____

This information is required when calling the factory for service.

Thern, Inc. warrants its products against defects in material or workmanship for two years from the date of purchase by the original using buyer, or if this date cannot be established, the date the product was sold by Thern, Inc. to the dealer. To make a claim under this warranty, contact the factory for an RGA number. The product must be returned, prepaid, directly to Thern, Inc., 5712 Industrial Park Road, Winona, Minnesota 55987. The following information must accompany the product: the RGA number, the date of purchase, the description of the claimed defect, and a complete explanation of the circumstances involved. If the product is found to be defective, it will be repaired or replaced free of charge, and Thern, Inc. will reimburse the shipping cost within the contiguous USA.

This warranty does not cover any damage due to accident, misuse, abuse, or negligence. Any alteration, repair or modification of the product outside the Thern, Inc. factory shall void this warranty. This warranty does not cover any costs for removal of our product, downtime, or any other incidental or consequential costs or damages resulting from the claimed defects. This warranty does not cover brake discs, wire rope or other wear components, as their life is subject to use conditions which vary between applications.

FACTORY AUTHORIZED REPAIR OR REPLACEMENT AS PROVIDED UNDER THIS WARRANTY IS THE EXCLUSIVE REMEDY TO THE CONSUMER. THERN, INC. SHALL NOT BE LIABLE FOR ANY INCIDENTAL OR CONSEQUENTIAL DAMAGES FOR BREACH OF ANY EXPRESS OR IMPLIED WARRANTY ON THIS PRODUCT. EXCEPT TO THE EXTENT PROHIBITED BY APPLICABLE LAW, ANY IMPLIED WARRANTY OF MERCHANTABILITY OR FITNESS FOR A PARTICULAR PURPOSE ON THIS PRODUCT IS LIMITED IN DURATION TO THE DURATION OF THIS WARRANTY.

Some states do not allow the exclusion or limitation of incidental or consequential damages, or allow limitations on how long an implied warranty lasts, so the above limitation or exclusion may not apply to you. This warranty gives you specific legal rights, and you may also have other rights which vary from state to state.

Note: Thern, Inc. reserves the right to change the design or discontinue the production of any product without prior notice.

About This Manual

The Occupational Safety and Health Act of 1970 states that it is the employer's responsibility to provide a workplace free of hazard. To this end, all equipment should be installed, operated, and maintained in compliance with applicable trade, industrial, federal, state, and local regulations. It is the equipment owner's responsibility to obtain copies of these regulations and to determine the suitability of the equipment to its intended use.

This Owner's Manual, and warning labels attached to the equipment, are to serve as guidelines for hazard-free installation, operation, and maintenance. They should not be understood to prepare you for every possible situation.

Information contained in this Owner's Manual is applicable only to the Thern 4HPF/4HWF/4HBN/4HBP Series Power Winches. Do not use this manual as a source of information for any other equipment.

The following symbols are used for emphasis throughout this manual:

⚠WARNING

Failure to follow 'WARNING!' instructions may result in equipment damage, property damage, and/or serious personal injury.

⚠CAUTION

Failure to follow 'CAUTION!' instructions may result in equipment damage, property damage, and/or minor personal injury.

Important!

Failure to follow 'Important!' instructions may result in poor performance of the equipment.



Suggestions for Safe Operation

⚠WARNING

DO the following:

Read and comply with the guidelines set forth in this Owner's Manual. Keep this manual, and all labels attached to the winch, readable and with the equipment at all times. Contact Thern, Inc. for replacements.

Check lubrication before use.

Install the wire rope securely to the winch drum.

Keep at least 4 wraps of wire rope wound on the drum at all times, to serve as anchor wraps. With less than 4 wraps on the drum the wire rope could come loose, causing the load to escape.

Keep hands away from the drum, gears, wire rope, and other moving parts of the equipment.

Equip the winch with a load brake if it is used to lift loads, or drag loads on an incline. Contact Thern Inc. for more information.

Keep all unnecessary personnel away from winch while in operation. Keep out of the path of the load and out of the path of a broken wire rope that might snap back and cause injury.

Disconnect electric power before servicing the equipment.

DO NOT do the following:

Do not lift people, or things over people. Do not walk or work under a load or in the line of force of any load.

Do not exceed the load rating of the winch or any other component in the system. To do so could result in failure of the equipment.

Do not use clutch equipped models to lift loads, or pull loads up an incline. Accidental release of the clutch could result allow the load to escape.

Do not use more than one winch to move a load unless each winch was designed for use in a multiple winch system.

Do not use damaged or malfunctioning equipment. To do so could result in failure of the equipment.

Do not modify the equipment in any way. To do so could cause equipment failure.

Do not wrap the wire rope around the load. This damages the wire rope and could cause the load to escape. Use approved rigging connectors to secure the wire rope to the load.

Do not operate the winch with drive guards or gear covers removed or improperly installed.

Do not divert your attention from the operation. Stay alert to the possibility of accidents, and try to prevent them from happening.

Do not jerk or swing the load. Avoid shock loads by starting and stopping the load smoothly. Shock loads overload the equipment and may cause damage.

Do not leave a suspended load unattended unless specific precautions have been taken to secure the load and keep people away from the winch and out from under the load.

Do not adjust the brake with the winch holding a load. Accidental release of the brake could result in loss of the load.

1.1 Installing the Winch

Important!

- Inspect the winch immediately following installation according to the Instructions for Periodic Inspection. This will give you a record of the condition of the winch with which to compare future inspections.
- A qualified professional should inspect or design the foundation to insure that it will provide adequate support.
- Locate the winch so it will be visible during the entire operation.
- When positioning the winch use the lifting holes provided or a sling wrapped around drum.
- Do not attempt to lift or position winch by using lifting hole on reducer. This hole is designed to lift reducer only.
- Do not weld the winch frame to the foundation or support structure. Welding the frame may void warranty, contact Thern, Inc. Use fasteners as instructed.

⚠WARNING

Do not install the winch in an area defined as hazardous by the National Electric Code, unless installation in such an area has been thoroughly approved.

Do not install the winch near corrosive chemicals, flammable materials, explosives, or other elements that may damage the winch or injure the operator. Adequately protect the winch and the operator from such elements.

Position the winch so the operator can stand clear of the load, and out of the path of a broken wire rope that could snap back and cause injury.

Attach the winch to a rigid and level foundation that will support the winch and its load under all load conditions, including shock loading.

- 1.1.1 CONSULT APPLICABLE CODES AND REGULATIONS for specific rules on installing the equipment.
- 1.1.2 LOCATE THE WINCH in an area clear of traffic and other obstacles. Make sure the winch is accessible for maintenance and operation.
- 1.1.3 LOCATE THE WINCH in an area with adequate temperatures. Check the motor and reducer manufacturer's information for ambient temperature ratings.
- 1.1.4 POSITION THE WINCH to allow access for proper lubrication.
- 1.1.5 INSTALL THE WINCH on a horizontal surface. The winch is designed and assembled for horizontal base mounting. **Special consideration must be taken if mounting vertically or upside-down. Please contact Thern, Inc.**
- 1.1.6 MAINTAIN A FLEET ANGLE between 1/2 and 1-1/2 degrees. The proper fleet angle minimizes wire rope damage by helping the wire rope wind uniformly onto the drum. See Figure 1.
- 1.1.7 FASTEN THE WINCH SECURELY to the foundation.
 - a For Standard products referred to in this manual, use coarse thread fasteners, grade 5 or better. Be sure to check the torque required for your fastener selection before mounting winch. Make sure the winch is secured to a solid foundation able to support the winch and the load under all conditions with design factors based on accepted engineering practices.
 - b Non-standard products that vary from the original design may have different fastening requirements. Contact a structural engineer or Thern, Inc. for this information.

CONTACT A QUALIFIED PROFESSIONAL FOR MOUNTING INSTRUCTIONS TO COMPLY WITH LOCAL CODES.

1.2 Installing the Breather Plug

Important!

- Save the sealed plug for use when the winch is removed for storage or transport.

⚠ CAUTION

Install the breather plug to vent heat and pressure. Failure to do so could result in pressure buildup which could damage the reducer.

For shipment, the reducer is filled with lubricant and sealed to prevent lubrication loss.

SEW Eurodrive and Nord reducers are supplied with the breather plug installed. To prevent build-up of excessive pressure, sealed vents on the breather must be activated prior to gear unit start up.

On SEW Eurodrive reducers the black rubber seal located on the breather plug **MUST BE REMOVED**. On Nord reducers the rubber string located on the breather **MUST BE REMOVED**. Refer to the reducers manufacturer's instructions.

Some units supplied may not have a breather plug installed for shipment. Install the breather plug before operation.

- 1.2.1 REMOVE THE SEALED PLUG from the breather plug hole.
- 1.2.2 CHECK THE LUBRICANT LEVEL in the reducer to make sure no lubricant was lost during shipment. Refer to the reducer manufacturer's instructions.
- 1.2.3 INSTALL THE BREATHER PLUG. The breather plug is wired to the reducer or attached in a plastic bag. Refer to the reducer manufacturer's information.

Important!

- Use a sheave or roller guide to direct the wire rope to the drum whenever possible.
- Install sheaves, tracks and other equipment so they will remain fixed under all load conditions. Follow the recommendations of the equipment manufacturer.
- Use sheaves of proper diameter to minimize wear on the wire rope. Follow the recommendations of the sheave manufacturer.

Figure 1 – Maintaining the Fleet Angle

When wire rope travels over a sheave or through a roller guide – maintain fleet angle by locating the sheave or guide an appropriate distance from the drum, shown as distance "A".

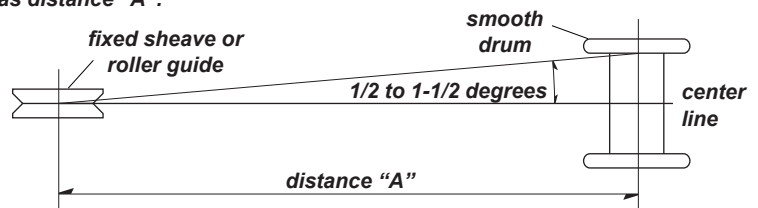

When wire rope travels directly to the load – maintain fleet angle by controlling side-to-side movement of the load with tracks or guide rails. Allowing the load to move too far to one side causes stress on the drum flange which may cause damage.

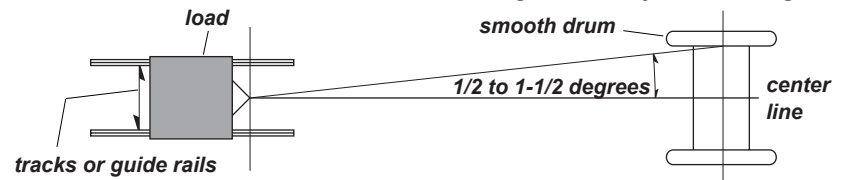

1.3 Connecting Electric Power

Important!

- Use electrical equipment with the correct rating and Underwriter's Laboratory (UL) approved.
- Always disconnect electric current when the winch is not in use.

⚠WARNING

Install proper branch circuits, disconnect devices, protection, and grounding as required by article 430 of the National Electric Code.

All electrical work must be performed by a licensed electrician. Failure to do so could result in electric shock or poor winch operation.

All control devices must be momentary contact type. Install all control devices so the winch motor will stop when the operator releases the device.

Locate control devices so the operator will be able to view the load through the entire operation.

Locate control devices so the operator will be clear of the load, the wire rope, and the path of a broken wire rope that could snap back and cause injury.

Figure 2 – Installing the Wire Rope – Recessed Anchor

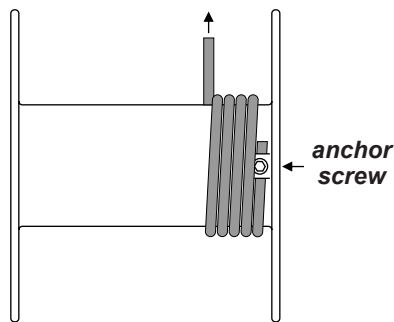

correct

typical installation shown right lay – underwound

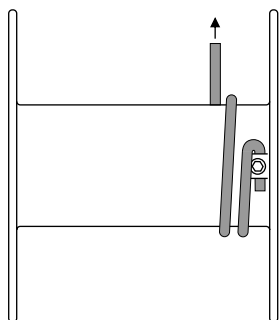

incorrect

It is the responsibility of the owner to provide equipment for controlling the winch. Electrical control packages are available from Thern. The following guidelines are supplied as a reference for the installer.

- 1.3.1 CONSULT APPLICABLE CODES AND REGULATIONS for specific rules on electrical installation.
- 1.3.2 CHECK THE COMPONENT MANUFACTURER'S INSTRUCTIONS for installing and connecting the motor, brake, and other equipment.
- 1.3.3 INSTALL A FUSE or circuit breaker in the power supply circuit, as required by the National Electric Code.
- 1.3.4 INSTALL A DISCONNECT DEVICE in the power supply circuit, as required by the National Electric Code. This should be a switch you can lock in the OFF position to prevent unauthorized use of the winch.
- 1.3.5 CONNECT ELECTRIC STARTER CONTROLS to the motor. Make sure the load brake is wired for fast braking on brakemotors that offer this function. Check the component manufacturer's information.
- 1.3.6 CONNECT ELECTRIC POWER SUPPLY, with ground wire, to the electric starter control box. Check the component manufacturer's information for a wiring diagram.
- 1.3.7 CONNECT OTHER ELECTRIC EQUIPMENT to the proper terminals in the electric control box.
- 1.3.8 CHECK THE CURRENT at the motor and make sure it agrees with the current rating marked on the winch nameplate. If current rating is incorrect, have the circuit inspected by a licensed electrician.
- 1.3.9 TEST ELECTRICAL CONNECTIONS by operating the winch.
 - a ROTATION OF THE DRUM must agree with the labels on the control device, either UP and DOWN, or FORWARD and REVERSE.
 - b CHECK THE LOAD BRAKE, make sure it releases when the motor is ON, and engages when the motor is OFF. **Make sure the fast brake function operates correctly on brakemotors that include this feature.**

CONTACT THE FACTORY OR A QUALIFIED PROFESSIONAL FOR HELP.

1.4 Installing the Wire Rope

Important!

- Use wire rope and other rigging equipment rated for the size of the largest load you will be moving.
- Do not drag the wire rope through dirt or debris that could cause damage, or poor operation.
- Always wear protective clothing when handling wire rope.

Figure 3 – Installing the Wire Rope – Flange Anchor

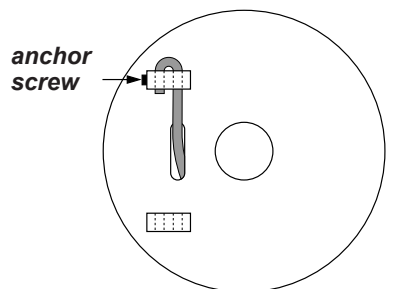

correct

pass wire rope through slot in flange and into anchor

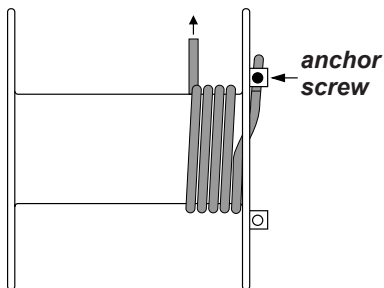

correct

typical installation shown right lay – underwound

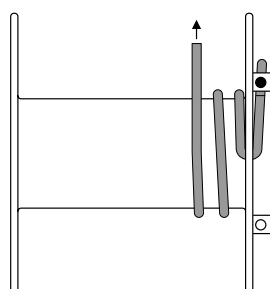

incorrect

⚠ WARNING

Install the wire rope securely to the winch drum. A poorly secured wire rope could come loose from its anchor and allow the load to escape.

- 1.4.1 DETERMINE WHICH DIRECTION the drum must rotate to wind and unwind wire rope.
- 1.4.2 PURCHASE THE PROPER WIRE ROPE for your application. Keep the following in mind when selecting a wire rope. Contact a reputable wire rope supplier for help.
 - a BREAKING STRENGTH of new wire rope should be at least 3 times greater than the largest load placed on the winch. If loads are lifted or pulled on an incline, the breaking strength must be at least 5 times greater than the largest load. These are minimum values and will vary with the type of load and how you are moving it.
 - b WIRE ROPE LAY must agree with the winding direction of the drum to help insure proper winding.
 - c WE RECOMMEND 7 x 19 galvanized aircraft cable for diameters up to 5/16 inch, and 6 x 37 IWRC improved plow steel (IPS) or extra improved plow steel (EIPS) wire rope for diameters of 3/8 inches and up.
- 1.4.3 ANCHOR THE WIRE ROPE to the drum using either the recessed or flange anchor.
 - a FOR RECESSED ANCHOR INSTALLATION. See Figure 2.
 - PASS THE WIRE ROPE under the drum from the front and through the recessed anchor hole. Make sure at least 1/2 inch of wire rope extends past the set screw, and the end of the wire rope does not protrude out where it will interfere with wire rope winding onto the drum.
 - TIGHTEN THE SETSCREW in the recessed anchor block to securely hold the wire rope in place.
 - b FOR FLANGE ANCHOR INSTALLATION. See Figure 3.
 - PASS THE WIRE ROPE under the drum from the front and through the slot in the drum flange.
 - LOOP THE WIRE ROPE through both holes in the anchor block so the end of the wire rope is located in the hole with the anchor screw. Make sure at least 1/2 inch of wire rope extends past the set screw, and the end of the wire rope does not protrude out where it will hit other components as the drum is turning. **Models may come with only one flange anchor block or a flange anchor block with only one hole.**
 - TIGHTEN THE SETSCREW in the anchor block to securely hold the wire rope in place.
- 1.4.4 WIND FOUR FULL WRAPS of wire rope onto the drum by operating the winch while holding the wire rope taut. **These wraps serve as anchor wraps and must remain on the drum at all times.**

2.1 General Theory of Operation

Important!

- Limit nonuniform winding by keeping tension on the wire rope and by maintaining the proper fleet angle.
- To help insure rated performance, make sure voltage at the motor is equal to the motor's voltage rating.
- It is your responsibility to detect and account for different factors affecting the condition and performance of the equipment.

- 2.1.1 THE PULL REQUIRED to move the load must not exceed the load rating of the winch. Consider the total force required to move the load, not the weight of the load.
- 2.1.2 THIS EQUIPMENT CAN develop forces that will exceed the load rating. It is the responsibility of the equipment user to limit the size of the load. Inspect the equipment regularly for damage according to the instructions contained in this manual and in the component manufacturer's information.
- 2.1.3 USE A LOAD BRAKE on all winches used to lift loads or drag loads on an incline. Although a new worm gear winch may appear to hold the load in place, this characteristic will diminish with use. **Do not depend on winch gearing to hold the load in place.**
- 2.1.4 PERFORMANCE RATINGS of the equipment are affected by the amount of wire rope wound on the drum, the way in which it is wound, and the way the winch is used.
- DRUM CAPACITY depends on how tightly and evenly the wire rope is wound on the drum. Actual drum capacities are usually 25-30% less than values shown in performance Tables, due to loose winding and overlapping.
 - LINE SPEED increases with each additional layer of wire rope wound onto the drum. The weight of the load does not affect line speed.
 - LOAD RATING represents the maximum pull that can be placed on new equipment. Load ratings are assigned values for specific amounts of load travel or wire rope accumulation. The load rating decreases as layers of wire rope accumulate on the drum.
- 2.1.5 DUTY RATINGS refer to the type of use the equipment is subject to. Consider the following when determining duty rating.
- ENVIRONMENT: harsh environments include hot, cold, dirty, wet, corrosive, or explosive surroundings. **Protect the equipment from harsh environments when possible.**
 - MAINTENANCE: poor maintenance, meaning poor cleaning, lubrication, or inspection, leads to poor operation and possible damage of the equipment. **Minimize poor maintenance by carefully following the instructions contained in this manual.**
 - LOADING: severe loading includes shock loading and moving loads that exceed the load rating of the equipment. **Avoid shock loads, and do not exceed the load rating of the equipment.**
 - FREQUENCY OF OPERATION: frequent start and stop functions increase wear and shorten the life span of the gear train and load brake components. Lengthy operations cause lubrication to become hot, which also decreases the life span of the gear train. **Increase maintenance of the equipment if used in frequent operations.**

CONTACT THE FACTORY FOR MORE INFORMATION.

2.2 Breaking-In the Winch

- 2.2.1 BREAK-IN OCCURS during the first 10 hours of normal operation. During break-in, mating surfaces become polished, and clearances increase. This is desired for efficient operation of bearings and gears.
- 2.2.2 INSPECT THE WINCH following break-in according to the Instructions for Periodic Inspection. See section 3.3 Inspecting the Equipment.

2.3 Preparing for Operation

Important!

- When determining whether the load will exceed the load rating, consider the total force required to move the load.

⚠WARNING

Read and comply with the guidelines set forth in this Owner's Manual. Keep this manual, and all labels attached to the winch, readable and with the equipment at all times. Contact Thern, Inc. for replacements.

Do not lift people, or things over people. Do not walk or work under a load or in the line of force of any load.

Do not exceed the load rating of the winch or any other component in the system. To do so could result in failure of the equipment.

Equip the winch with a load brake if it is used to lift loads, or drag loads on an incline. Contact Thern Inc. for more information.

Do not use more than one winch to move a load unless each winch was designed for use in a multiple winch system.

Do not use damaged or malfunctioning equipment. To do so could result in failure of the equipment.

Do not modify the equipment in any way. To do so could cause equipment failure.

Do not operate the winch with drive guards or gear covers removed or improperly installed.

Check lubrication before use.

- 2.3.1 CONSIDER THE OPERATION. Do not begin until you are sure you can perform the entire operation without hazard.
- 2.3.2 INSPECT ALL COMPONENTS of the system.
- INSPECT THE WINCH and other equipment according to the Instructions for Frequent Inspection.
 - OPERATORS must be in good health, alert, thoroughly trained in operating the equipment, and properly clothed (hard hat, safety shoes and safety glasses, no loose clothing).
 - THE LOAD must be clear of other objects and free to move. Make sure the load will not tip, spin, roll away, or in any way move uncontrollably.
- 2.3.3 KNOW YOUR LOAD and make sure you do not exceed the load rating of the winch or any other equipment in the system.

2.4 Attaching the Load

Figure 4 – Attaching Load

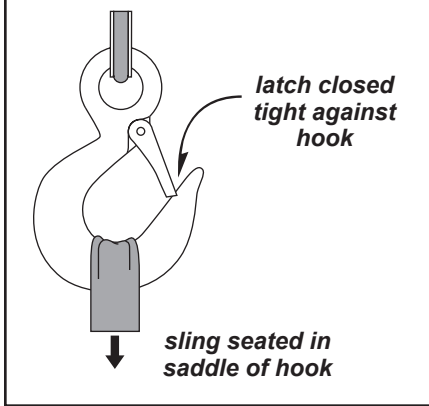

⚠WARNING

Do not wrap the wire rope around the load. This damages the wire rope and could allow the load to escape. Use a sling or other approved lifting device.

- 2.4.1 CLEAR OBJECTS from the path of the load so you can move it freely and observe it at all times during the operation.
- 2.4.2 ATTACH THE LOAD using a nylon sling, or other approved lifting device. Follow the recommendations of the sling manufacturer.
 - a SEAT THE SLING in the saddle of the hook with the hook latch completely closed. See Figure 4.
 - b CENTER THE LOAD on the hook so it will remain balanced and not tip or rotate to one side.

2.5 Moving the Load

Important!

- Obey a stop signal from anyone.
- Maintain tension on the wire rope to keep it tightly and evenly wound on the drum.
- If the winch and load are not visible during the entire operation, get help from another person.
- Appoint a supervisor if more than one person is involved in the operation. This will reduce confusion and increase safety.
- When lifting a load, use a tag line to keep the load from swinging or twisting, while keeping yourself away from the load.

⚠WARNING

Keep at least 4 wraps of wire rope wound on the drum at all times, to serve as anchor wraps. With less than 4 wraps on the drum the wire rope could come loose, causing the load to escape.

Keep all unnecessary personnel away from winch while in operation. Keep out of the path of the load and out of the path of a broken wire rope that might snap back and cause injury.

Keep hands away from the drum, gears, wire rope, and other moving parts of the equipment.

Do not divert your attention from the operation. Stay alert to the possibility of accidents, and try to prevent them from happening.

Do not jerk or swing the load. Avoid shock loads by starting and stopping the load smoothly. Shock loads overload the equipment and may cause damage.

Do not leave a suspended load unattended unless specific precautions have been taken to secure the load and keep people away from the winch and out from under the load.

- 2.7.1 MOVE THE LOAD slowly and smoothly, only a small distance at first. Make sure the load is balanced and securely attached before continuing.
- 2.7.2 USE THE CONTROL DEVICE to operate the winch. The control device should be momentary contact type, so the winch will stop when the operator releases the control.
- 2.7.3 OBSERVE THE WIRE ROPE as it winds onto the drum. If it becomes loose, uneven, or overlapped, stop the operation and rewind the wire rope before continuing. **Continued operation with overlapped or uneven wire rope can damage the wire rope and shorten its life.**
- 2.7.4 OBSERVE THE REDUCER during operation for signs of overheating. **Frequent overheating may be a sign of damage, or may indicate the need for a larger power winch.**
- a WATCH FOR SMOKE, the smell of burnt lubricant, and other signs of overheating. Use a thermocouple or other device to monitor reducer temperature.
 - b STOP THE OPERATION if the reducer overheats, and allow the winch to cool. **Continued operation may cause damage.**

2.6 Operating the Clutch (clutch models only)

▲WARNING

Do not use clutch equipped models to lift loads, or pull loads up an incline. Accidental release of the clutch could allow the load to escape.

Engage the clutch completely before operating the winch. Operating the winch with a released or partially engaged clutch may cause damage.

Do not engage or disengage the clutch with the winch under power or loaded.

- 2.6.1 DISENGAGE THE CLUTCH with the clutch handle, and unwind the wire rope for hook-up to the load.
- 2.6.2 ENGAGE THE CLUTCH with the clutch handle. You may need to rotate the drum by hand to align the clutch jaws.
- 2.6.3 ADJUST THE DRAG BRAKE if necessary, to control the rotation of the drum when the clutch is disengaged. Not all clutch models include a drag brake.

2.7 Emergency Operation

(for models equipped with this feature)

⚠WARNING

Do not adjust the brake with the load suspended. Accidental release of the brake could allow the load to escape.

Do not leave a suspended load unattended unless specific precautions have been taken to secure the load and keep unnecessary personnel away from the winch and from under the load.

- 2.7.1 IN CASE OF POWER FAILURE, turn the control device to OFF and DISCONNECT electric power. Leave electric power DISCONNECTED.
- 2.7.2 MAKE SURE SAFETY PRECAUTIONS have been taken to secure the load and keep unnecessary personnel away from the winch and from under the load while operating the emergency hand crank.
- 2.7.3 IF EQUIPPED WITH A BRAKE MOTOR you must disengage the brake on the motor before using the emergency hand crank. Operating the emergency hand crank with the brake on the motor engaged could result in equipment damage or failure.
 - a It is recommended for two people to operate the winch using the emergency hand crank. If the winch is equipped with a brake motor, assign one person to operate the hand crank while the other is assigned to operate the brake. Have control of the hand crank before disengaging the brake on the motor. Accidental release of the brake could allow the load to escape.
 - b If the winch is not equipped with a brake motor, assign one person to operate the hand crank while the other is assigned to observe and control the load.
 - c Always follow the brake manufacturers operating instructions for engaging or disengaging the brake.
- 2.7.4 DO NOT USE AN IMPACT WRENCH to operate the emergency hand crank option of the winch. To do so could result in equipment damage or failure. Use a drill-motor.
- 2.7.5 ENGAGE THE BRAKE and remove the handle or drill-motor before operating the winch under power.

ANY QUESTIONS ON OPERATING THE EMERGENCY HAND CRANK OPTION OR WINCH APPLICATION CONTACT THERN, INC.

3.1 Cleaning the Winch

Important!

Increase the frequency of maintenance procedures if the winch is:

- Operated for long periods.
- Used to pull heavy loads.
- Operated in wet, dirty, hot, or cold surroundings.

Clean the winch to remove dirt and help prevent rust and corrosion.

- 3.1.1 CLEAN THE WINCH every six months or whenever it is dirty.
- a WIPE ALL EQUIPMENT to remove dirt and grease.
 - b LEAVE A LIGHT FILM of oil on all surfaces to protect them against rust and corrosion.
 - c WIPE OFF excessive amounts of oil to avoid the accumulation of dirt.
- 3.1.2 REMOVE ALL UNNECESSARY OBJECTS from the area around the winch.

3.2 Lubricating the Winch

Important!

- Do not leave plug holes in the reducer open. Open plug holes will allow dirt and moisture to contaminate the lubrication.
- Make sure lubricant has a temperature rating appropriate for the ambient temperatures of the operation.
- Replace the motor bearings if the motor is disassembled for any reason.

Figure 5 – Lubricating the Flange Bearing

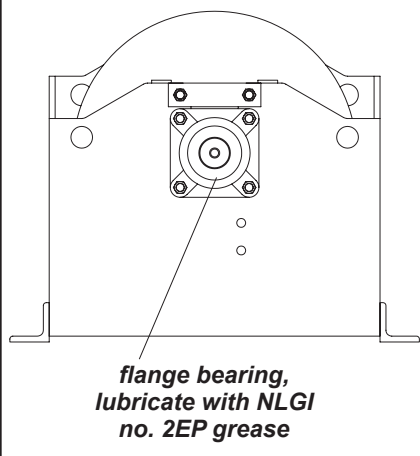

⚠ CAUTION

Make sure the breather plug is clean and open to vent heat and pressure. Poor ventilation may cause overheating and result in damage to oil seals and other equipment.

Fill the speed reducer to the proper level without overfilling. Too much or too little lubricant will cause overheating and result in damage to seals, bearings, and gears.

Lubricate the winch properly to help protect it from wear and rust. Read the following instructions carefully.

- 3.2.1 MOTOR BEARINGS are typically lubricated for life by the manufacturer. Some motors require periodic lubrication. Refer to the motor manufacturer's information for specific instructions.
- 3.2.2 LUBRICATE THE REDUCER according to the manufacturer's instructions.
 - a CHECK OIL LEVEL before every operation and every 10 hours during operation. Remove the level plug and make sure oil is even with the plug hole.
 - b FILL THE REDUCER according to the manufacturer's instructions. Fill the reducer until oil reaches the level plug. **Do not mix different lubricants.**
 - c CHANGE REDUCER LUBRICANT at least every 2 years, or whenever it is dirty or contaminated.
- 3.2.3 LUBRICATE FLANGE BEARING at least every 10 hours of operation. Insert NLGI #2 EP (Extreme Pressure) grease through the grease zerk. Refer to the bearing manufacturer's information for specific instructions. See Figure 5.
- 3.2.4 LUBRICATE THE WIRE ROPE by following the wire rope manufacturer's recommendations.

3.3 Inspecting the Equipment

Important!

- Start an inspection program as soon as you put the winch into use.
- Appoint a qualified person to be responsible for regularly inspecting the equipment.
- Keep written records of inspection. This allows comparison with comments from previous inspections so you can see changes in condition or performance.

Perform frequent inspections:

- Before each operation.
- Every 3 hours during operation.
- Whenever you notice signs of damage or poor operation.

Frequent Wire Rope Inspection:

- Use ASME B30.7 as a guideline for rope inspection, replacement and maintenance.
- Check the wire rope, end connections and end fittings for corrosion, kinking, bending, crushing, birdcaging or other signs of damage.
- Check the number, distribution and type of visible broken wires. See paragraph 3.3.4 c and Figure 6.
- Check the wire rope for reduction of rope diameter from loss of core support, or wear of outside wires. See Figure 8.
- Take extra care when inspecting sections of rapid deterioration such as sections in contact with saddles, sheaves, repetitive pickup points, crossover points and end connections.

⚠WARNING

Do not use damaged or malfunctioning equipment. Place an “OUT OF ORDER” sign on the winch. Do not use the winch until the sign is removed by a qualified maintenance person who has completely corrected the problem.

Inspect the winch to detect signs of damage or poor operation before they become hazardous. See Table 1 - Inspection Checklist.

3.3.1 CONSULT APPLICABLE CODES AND REGULATIONS for specific rules on inspecting the winch and other equipment.

3.3.2 CHECK COMPONENT MANUFACTURER’S INSTRUCTIONS for inspecting the motor, brake, reducer, bearings, wire rope, and other equipment.

3.3.3 Instructions for Frequent Inspection

- a VISUALLY INSPECT the entire winch and all other equipment involved in the operation.
 - Check all equipment for cracks, dents, bending, rust, wear, corrosion and other damage.
 - Make sure the wire rope is installed correctly and anchored securely to the drum.
 - Check the reducer for signs of leakage.
 - Make sure the entire winch is properly lubricated.
 - Make sure the breather plug is clean, open, and installed correctly.
 - Make sure mounting fasteners are tightened securely.
 - Make sure the foundation is in good condition, and capable of supporting the winch and its load under all load conditions.
 - Check electrical wiring and connections for wear, corrosion, cuts, and other damage.
 - Check clutch operation, if applicable, to make sure it moves freely and engages completely.
- b TEST WINCH PERFORMANCE by operating the winch with a load not exceeding the load rating.
 - Listen for unusual noises, and look for signs of damage as you operate the winch.
 - Make sure the wire rope winds evenly and tightly onto the drum. If it is loose or uneven, rewind it before continuing.
 - Make sure the load moves smoothly, without hesitation or strain.
 - Make sure the winch responds to the control device. It must rotate as shown on the control labels, and it must turn off when you release the control.
 - Check the brake. Raise the load, then lower it and stop it a few feet off the ground. If the load continues to coast or creep, the brake needs adjustment. Refer to brake manufacturer’s instructions.

Completely correct all problems before continuing. Use the Troubleshooting Chart to help determine the cause of certain problems. See Table 2.

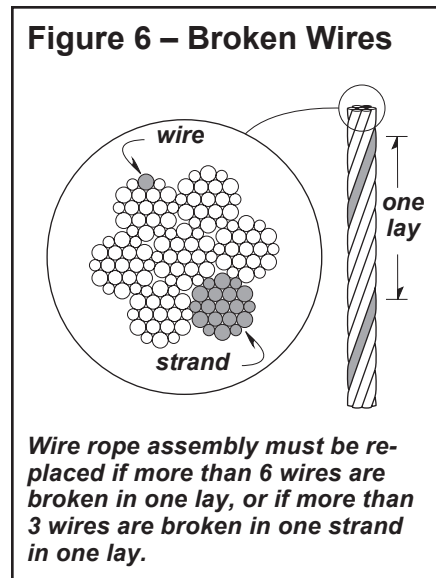

Perform periodic inspections:

- Every 6 months.
- Whenever you return the winch to service from storage.
- Whenever you notice damage or poor operation in a frequent inspection.
- Whenever you have, or think you may have, overloaded or shock loaded the winch.

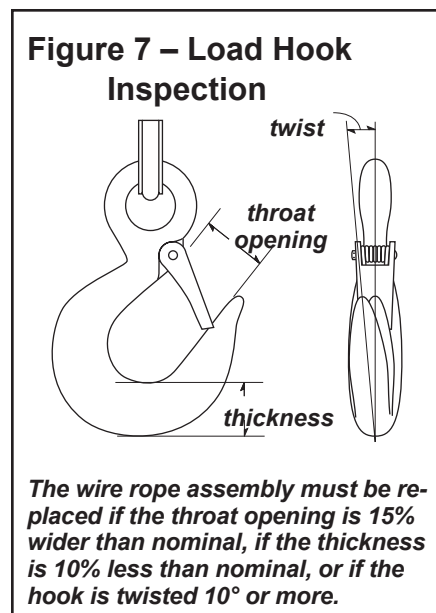

3.3.4 **Instructions for Periodic Inspection**

- a VISUALLY INSPECT the winch and all other equipment.
 - Check the finish for wear, flaking, or other damage.
 - Check all equipment for cracks, dents, bending, rust, wear, corrosion and other damage. If the equipment was overloaded, or if you notice cracks or other signs of overloading and damage promptly remove equipment from use and have it repaired or replaced. **DO NOT CONTINUE TO USE DAMAGED OR OVERLOADED EQUIPMENT OR WIRE ROPE.**
 - Check all fasteners for stripped threads, wear, bends, and other damage.
 - Check the gearbox for signs of leakage. Contact the factory if there are any signs of lubricant leaking from the gearbox.
 - Make sure the breather plug is clean, open and installed correctly,
 - Make sure the entire winch is properly lubricated.
 - Check clutch operation, if applicable, to make sure it moves freely and engages completely.
 - Make sure all labels and plates are readable, firmly attached, free of damage and clean. Replacements are available from the factory.
- b DRAIN A SMALL AMOUNT OF LUBRICANT from the reducer into a clean container.
 - Check the lubricant for dirt, metal particles, water, and other signs of contamination. Completely drain the reducer if lubricant is contaminated.
- c INSPECT THE WIRE ROPE according to the wire rope manufacture's recommendations or follow accepted industry standards for wire rope inspections.
 - Always wear protective clothing when handling wire rope.
 - Check the entire length of wire rope for bent wires, crushed areas, broken or cut wires, corrosion, and other damage. Carefully inspect areas that pass over sheaves or through roller guides.
 - Note the location and concentration of broken wires. Replace wire rope if more than 6 wires are broken in one lay, or more than 3 wires are broken in one strand in one lay. See Figure 6.
 - Make sure the load hook or other device is securely attached to the wire rope, and the wire rope where it is attached is not frayed, corroded, broken, or otherwise damaged.
 - Measure the throat opening, thickness, and twist of the hook. Replace the hook if it shows signs of damage. See Figure 7.
 - Make sure hook latch opens without binding and closes when released.
 - Check the anchor holes in the drum and the surrounding area for signs of wear or distortion.
- d PLACE enough weight to keep the wire rope straight and tightly drawn.
 - Measure the diameter of the wire rope, especially in areas where wear is noticeable. Replace the wire rope if the diameter measures below the minimum diameter at any point. See Figure 8.

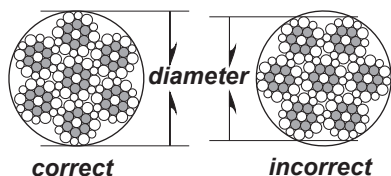
Figure 8 – Rope Diameter

The wire rope assembly must be replaced if the diameter measures less than the minimum diameter at any point.

wire rope diameter	minimum diameter
up to 5/16 in	1/64 in (.0156 in)
up to 1/2 in	1/32 in (.0313 in)
up to 3/4 in	3/64 in (.0469 in)
up to 1-1/8 in	1/16 in (.0625 in)
up to 1-1/2 in	3/32 in (.0938 in)

- e MOVE THE DRUM with your hands.
 - Check for excessive movement indicating worn or loose gears or bearings. Excessive movement is caused by overloading or overheating, and is a sign that your application may require a larger power winch.
 - Disassemble the winch if necessary. Inspect keys, bearings, seals, and shafts for wear, distortion, and other damage.
- f INSPECT THE FOUNDATION AND RIGGING
 - Check mounting fasteners for stripped threads, wear, and other damage.
 - Check the foundation for cracks, corrosion, and other damage.
- g TEST WINCH PERFORMANCE by operating the winch with a load not exceeding the load rating.
 - Listen for unusual noises, and look for signs of damage as you operate the winch.
 - Make sure the wire rope winds evenly and tightly onto the drum. If it is loose or uneven, rewind it before continuing.
 - Observe the rotating drum, look for signs of loose or misaligned bearings.
 - Make sure the load moves smoothly without hesitation or strain.
 - Make sure the winch responds to the control device. It must rotate as shown on the control labels, and it must turn off when you release the control.
 - Check the brake. Raise the load, then lower it and stop it a few feet off the ground. If the load continues to coast or creep, the brake needs adjustment. Refer to brake manufacturer's instructions.
- h DISCONNECT ELECTRIC POWER and inspect electrical equipment.
 - Check electrical wires for worn insulation, cuts, corroded connections, and other damage.
 - Check voltage of electrical supply with a UL approved voltmeter. If voltage is low, have a licensed electrician inspect the circuit.
 - Make sure the electrical control box is securely installed. Look inside the control box for signs of moisture, corrosion, burn marks, cracks, and other damage.
- i CONNECT ELECTRIC POWER.

Completely correct all problems before continuing. Use the troubleshooting chart to help determine the cause of certain problems. See Table 2.

Table 1 – Inspection Checklist

checked boxes indicate damage or problem in need of repair

	damages	problems
general	<input type="checkbox"/> finish weathered, flaking, otherwise damaged <input type="checkbox"/> parts cracked, bent, rusted, worn, otherwise damaged	<input type="checkbox"/> winch jerks or hesitates during operation <input type="checkbox"/> unusual noises, other signs of malfunction
fasteners	<input type="checkbox"/> stripped threads, bent, worn, otherwise damaged	<input type="checkbox"/> loose, not tightened to proper torque
reducer	<input type="checkbox"/> gears, bearings, or shafts loose, worn, otherwise damaged <input type="checkbox"/> lubricant leakage	<input type="checkbox"/> not properly lubricated <input type="checkbox"/> lubricant contaminated
wire rope	<input type="checkbox"/> bent, crushed, otherwise damaged <input type="checkbox"/> broken wires, see Figure 6 replace if more than 6 wires in one lay, or 3 wires in one strand in one lay, are broken <input type="checkbox"/> diameter reduced, see Figure 8 replace if less than 45/64" (.703 inch)	<input type="checkbox"/> wire rope loosely or unevenly wound number per strand = _____ number per lay = _____ diameter = _____
end connections	<input type="checkbox"/> corroded, rusted, worn, otherwise damaged	<input type="checkbox"/> not securely attached
hook or other device	<input type="checkbox"/> twisted, bent, worn, otherwise damaged, see Figure 7 replace if twist is 10 degrees or more, replace if throat width is 15% larger than nominal replace if thickness is 10% less than nominal	<input type="checkbox"/> hook latch fails to close when released twist = _____ throat width = _____ thickness = _____
drum	<input type="checkbox"/> anchor hole worn, distorted, otherwise damaged	<input type="checkbox"/> excessive movement or backlash
motor	<input type="checkbox"/> motor burnt out, otherwise damaged	<input type="checkbox"/> voltage at motor low
brake	<input type="checkbox"/> brake worn, broken, otherwise damaged	<input type="checkbox"/> brake does not operate properly
control device	<input type="checkbox"/> electric components corroded, burnt, otherwise damaged	<input type="checkbox"/> fails to control winch properly
electric circuit	<input type="checkbox"/> electric wires worn, cut, corroded, otherwise damaged <input type="checkbox"/> connections loose, corroded, otherwise damaged	<input type="checkbox"/> wires unprotected, obstructing traffic voltage at motor = _____
labels and plates	<input type="checkbox"/> dirty, illegible, otherwise damaged	<input type="checkbox"/> loosely attached or missing
comments	_____ _____ _____ _____ _____ _____ _____ _____ _____ _____	
authorized signature	_____	date _____

Table 2 – Troubleshooting Chart

Contact the factory for assembly/disassembly instructions. Disassembly of the gearbox before contacting Thern, Inc. voids all warranties.

problem	cause	correction
motor won't run	<ul style="list-style-type: none"> • circuit breaker tripped or fuse blown reset circuit breaker or replace fuse • electrical connections loose or damaged inspect, repair and tighten as necessary • electric power supply failure contact power company • motor burnt out or damaged repair or replace as necessary 	
motor runs, drum doesn't turn	<ul style="list-style-type: none"> • loose or broken gear keys inspect and replace as necessary • loose, stripped or broken gears inspect and replace as necessary 	
motor tries to turn but can't	<ul style="list-style-type: none"> • unit overheated allow to cool • load too heavy lighten load • voltage at motor too low inspect supply circuit and rewire as needed • electric brake not operating properly inspect and repair as necessary • gears or bearings broken or locked inspect and replace as necessary 	
brake does not operate properly	<ul style="list-style-type: none"> • brake release lever in release position move to lock position • voltage to brake incorrect check voltage at control box, repair as needed • brake adjusted incorrectly adjust brake • brake discs or solenoid worn or damaged inspect and replace as necessary • brake components seized up or damaged inspect and repair as necessary 	
lubricant leakage	<ul style="list-style-type: none"> • worn bearings inspect and replace as necessary • damaged oil seals or gaskets inspect and replace as necessary • cracked or damaged reducer inspect and repair as necessary 	
excessive end play on drive shaft	<ul style="list-style-type: none"> • loose or damaged keys or keyways inspect and replace as necessary • excessively worn gears inspect and repair as necessary 	
excessive worn gears or bearings	<ul style="list-style-type: none"> • load too heavy lighten load • poor lubrication of reducer or bearings inspect and lubricate as necessary 	
overheating	<ul style="list-style-type: none"> • operated too long without rest allow to cool • load too heavy lighten load • poor lubrication inspect and lubricate as necessary • breather plug clogged or damaged clean or replace breather plug • bearing seized up inspect and replace as necessary 	
unusual noises		
high pitched squeak	<ul style="list-style-type: none"> • poor lubrication inspect and lubricate as necessary 	
grinding noise	<ul style="list-style-type: none"> • contaminated oil drain, clean and lubricate the winch • broken gears or bearings inspect and replace as necessary 	
whining motor	<ul style="list-style-type: none"> • load too heavy lighten load • motor overheated allow to cool • motor bearings burnt out replace motor or bearings 	
rattling noise	<ul style="list-style-type: none"> • loose fasteners or setscrews tighten all bolts and screws • worn or loose drag brake inspect and repair or tighten as necessary 	
heavy thump during operation	<ul style="list-style-type: none"> • contaminants in lubricant drain, clean and lubricate the winch • loose setscrews or keys in gears or shafts inspect and repair as necessary • bearings defective inspect and replace as necessary 	

3.4 Repairing the Winch

Important!

- It is your responsibility to determine when to replace parts. When considering whether to continue using a part or to replace it, remember that replacing it is the best way to avoid further equipment damage.
- Replace spring pins, retaining rings, and oil seals whenever the winch is disassembled for inspection or repair.
- Appoint a qualified person to be responsible for all repairs to the equipment.

- 3.4.1 GET FACTORY AUTHORIZATION for all repairs. Unauthorized repairs will void the warranty, and may lead to damage or failure of the winch.
- 3.4.2 REPLACE DAMAGED OR POORLY OPERATING PARTS with Thern repair parts.
- 3.4.3 REFINISH AREAS where the paint is worn or flaking. A good finish helps to protect against corrosion and weather damage.
 - a REMOVE THE FINISH from damaged areas, down to the bare metal.
 - b CLEAN THE AREA thoroughly.
 - c REPAINT with a high quality primer and finishing coat.
- 3.4.4 TO ORDER REPAIR PARTS, contact your local dealer. Include the following information when ordering:
 - model number
 - serial number (or code number)
 - part number
 - date purchased, and from whom
 - description of what happened, or what is wrong
 - your name and return address

4.1 Transporting the Winch

Important!

- Keep a record of what you ship, and when you send it.

- 4.1.1 ENSURE THE BREATHER is in the upper most position on the reducer to prevent the loss of lubrication during shipment.
- 4.1.2 PACK THE WINCH in an upright position for transport, using the original packaging materials, if possible.
 - a FASTEN THE WINCH to a wooden base using bolts, to keep it from moving during transport.
 - b SEAL THE WINCH in plastic with a desiccant to help protect it from rust, corrosion, and other damage.
 - c CONSTRUCT WOODEN SIDES and top to enclose the winch in a solid protective crate.
 - d PACK LOOSE PARTS in small boxes or ship separately.
- 4.1.3 INSPECT THE WINCH according to the Instructions for Periodic Inspection before installing it in a new location.

4.2 Storing the Winch

- 4.2.1 FILL THE REDUCER with lubricant, and make sure the breather plug is clean and properly installed. Add a rust preventative for long term storage. Follow the reducer manufacturer's instructions.
- 4.2.2 SEAL THE WINCH in plastic with a desiccant to help protect it from rust, corrosion, and other damage.
- 4.2.3 STORE THE WINCH upright, in a cool clean place away from corrosive chemicals and moisture.
- 4.2.4 ROTATE THE DRUM PERIODICALLY to keep bearing and gears surfaces from becoming lacquered. Release the brake to rotate the drum.
- 4.2.5 INSPECT THE WINCH according to the Instructions for Periodic Inspection before installing it for operation.
- 4.2.6 TEST INSULATION RESISTANCE in the motor to detect moisture damage. Refer to the motor manufacturer's instructions.
- 4.2.7 DRAIN THE REDUCER and fill with proper lubricant prior to operation. See section 3.2 Lubricating the Winch.



Thern, Incorporated
5712 Industrial Park Road
Winona, MN 55987

PHN 507-454-2996
FAX 507-454-5282

EMAIL: info@thern.com
www.thern.com

Thern Europe

Regional Headquarters

Amsterdam Schiphol Tetra
Siriusdreef 17-27
2132 WT Hoofddorp
The Netherlands

Phone: +31-546-898-380
Email: europe@thern.com