

51"-66" TELESCOPIC SPREADER ASSEMBLY, WLL 28,000 LB. (AC22T-03-066-PA)

Cage Code: 65059 | Drawing No: SAC22T-03-066-PA | Revision: - | Sheet: 1 of 1

UNLESS OTHERWISE SPECIFIED, DIMENSIONS ARE IN INCHES

KIT INCLUDES:

1. ONE PIPE ADAPTER FOR OVER ONE END CAP
2. ONE OUTER PIPE
3. ONE INNER PIPE
4. ONE OUTER PIPE PIN
5. ONE ADJUSTMENT PIN

NOTES:

1. PART NO.: AC22T-03-066-PA, 51"-66" TELESCOPIC SPREADER ASSEMBLY KIT
2. WLL: 28,000 LB.
3. PROOF TESTED TO 125% (35,000 LB.) AND CERTIFIED
4. STANDARD SPECIFICATION # EAD21000A APPLIES
5. FINISH: SANDBLAST, PRIME AND PAINT SAFETY YELLOW
6. CALCULATED WEIGHT: 80 LB.
7. DESIGNED AND MANUFACTURED TO MEET OR EXCEED ASME B30.20 AND BTH-1, DESIGN CATEGORY B, SERVICE CLASS 0.

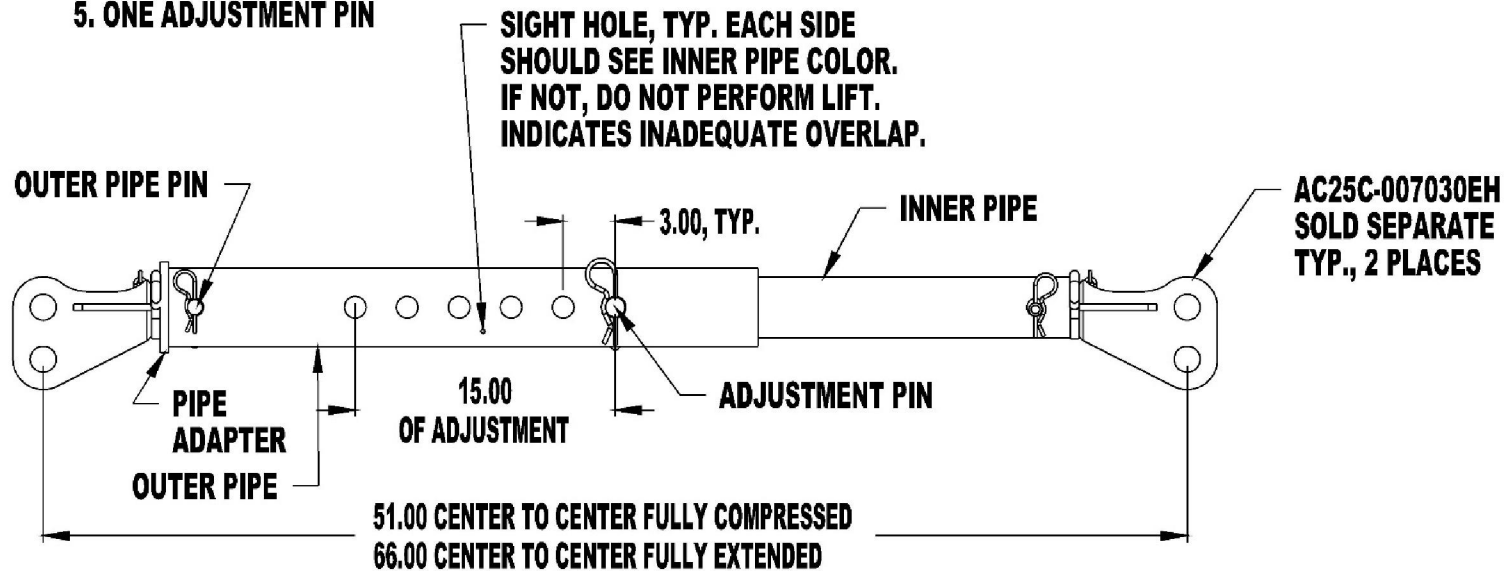

To avoid lifter failure, potential death and property damage, never exceed WLL (Working Load Limit).

This document contains the proprietary information of Tandemloc, Inc. and your access and use shall be, and is at all times, pursuant to and limited by the Tandemloc, Inc. Terms of Use.

You shall not, and shall not encourage, assist, or authorize another party to copy, distribute, publicly display, modify, reverse engineer, decompile, or take any other action to reproduce this document or the information contained herein. © Copyright 2014 by Tandemloc, Inc.

Dimensions are subject to manufacturing tolerance and change.



Email: info@tandemloc.com • www.tandemloc.com

824 Highway 101 • Havelock, NC 28532

Tel: 1.800.258.7324 (252.447.7155)

FAX 1.800.892.3273 (252.447.5502)

Tandemloc, Inc. designs, manufactures and tests lifting, securing and mobilizing components for all industries. See our website for details and important safety information.

Read all safety labels and instructions prior to use. Product to be used by qualified personnel only.