

NTH Low Headroom Trolley Hoist

1, 2, 3, and 5 Ton capacity

Harrington's NTH low headroom trolley hoist combines economical, trouble-free CF hoist performance with the space savings of an integral trolley. The NTH is ideal for applications requiring a low headroom hoist and trolley combination. Both push and geared trolley versions are available to best suit your application.

Many Benefits from More Features:

- Lift the load in tight quarters thanks to low headroom profile.
- Get the features, benefits, and capabilities of Harrington's CF hand chain hoist.
- Trolley moves smoothly on cast-iron flanged wheels equipped with sealed, lubed-for-life ball bearings.
- Easily adjust trolley to fit a wide variety of beam flange widths.

Capabilities to Count On:

- 10-foot lift is standard; nonstandard lifts and hand chain drops are also available.
- Trolley available in plain or geared models.
- Trolley wheels accommodate tapered or flat-flanged beams.
- Grade 100 heat-treated manganese alloy load chain resists abrasion and wear while minimizing chain weight.
- Forged and heat-treated alloy steel hooks are designed to open slowly and not fracture under excessive loads.
- Test certificate verifies that every hoist has been factory load tested to 125% of rated capacity, in accordance with ASME B30.16 requirements.

Options: (See pages 30–31)

- Chain container
- Corrosion-resistant chain
- Inspection hook

Also available—patented track applications; consult factory for details.



NTH LOW HEADROOM TROLLEY HOIST — DIMENSIONS

Cap. (Tons)	a (in)	a' (in)	b (in)	d (ft)	e (in)	e' (in)	f (ft)	g (in)	h (in)	i (in)	j (in)	k (in)	k' (in)	m (in)	n (in)	r (in)	t (in)
1	8.1	12.9	10.9	10.0	1.0	5.9	10.4	1.1	4.2	2.80	0.8	3.5	4.4	1.9	4.6	1.9	0.75
2	9.3	14.0	13.8		1.2	6.0		1.4	5.0	3.35		4.2	4.7	2.3	5.4	2.3	1.00
3	9.9	14.5	15.6		1.3	5.9	10.8	1.7	5.8	3.94	4.9	5.0	2.4	6.2	2.4	1.13	
5	11.2	15.8	18.3	10.6	1.5	6.2	11.3	1.8	6.7	4.65	1.0	5.6	5.1	3.0	7.0	2.9	1.63

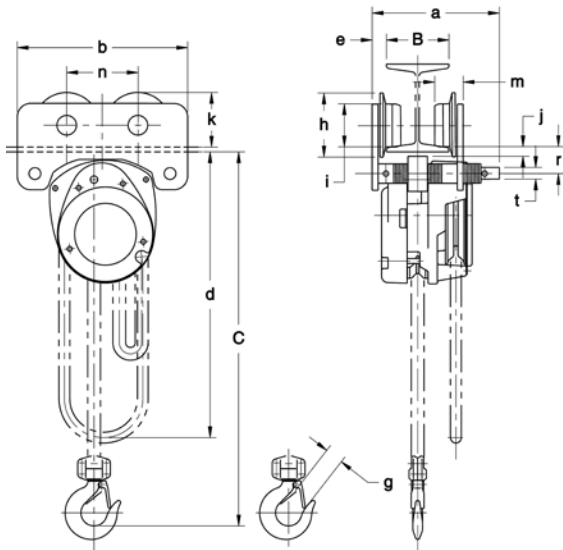

NTH (Push Trolley Model)

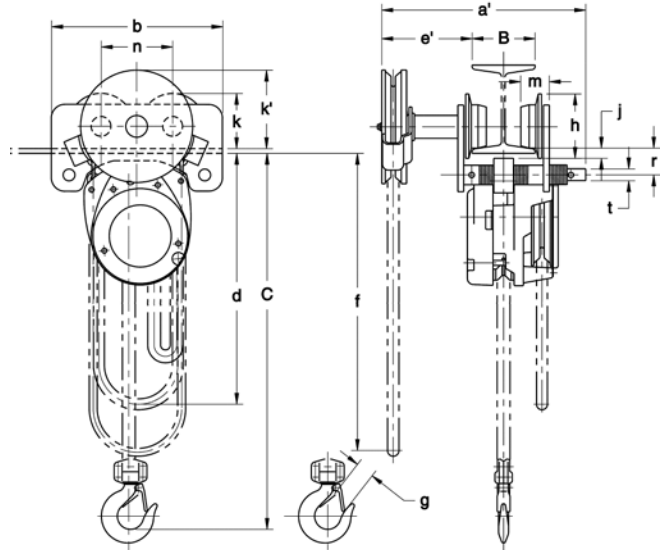

G-NTH (Geared Trolley Model)

NTH LOW HEADROOM TROLLEY HOIST — SPECIFICATIONS

Cap. (Tons)	Product Code		Head room C (in)	Std. Lift (ft)	Pull to Lift Load (lbs)	Overhaul Ratio	Min. Radius for Curve (in)	Flange Range B (in)*	Load Chain Dia. (mm) x Chain Fall Lines	Push			Geared		
	Push Trolley	Geared Trolley								Net Weight (lbs)	Shipping Weight (lbs)	Weight for Additional One Foot of Lift (lbs)	Net Weight (lbs)	Shipping Weight (lbs)	Weight for Additional One Foot of Lift (lbs)
1	NTH010	G-NTH010	12.5	10	72	31	39	2.32-5.16	6.3 x 1	62	65	1.2	73	78	1.8
2	NTH020	G-NTH020	16.5		80	63	47	3.72-5.97	6.3 x 2	92	97	1.8	103	110	2.4
3	NTH030	G-NTH030	19.0		92	81	59	3.62-6.26	7.1 x 2	125	133	2.1	136	177	2.8
5	NTH050	G-NTH050	20.3		134	79	5.12-7.11	7.1 x 3	188	200	2.9	199	240	3.5	

Please Note: Special lengths of load and hand chain available upon request.
 *Other beam widths available. Consult factory.
 Weights are approximate.